



MEDIANA HEARTON AED A16

Automated External Defibrillator

OPERATORS MANUAL

EU representative

EC REP OBELIS S.A

Bd. Général Wahis, 53, 1030 Brussels, Belgium

Manufacturer

 **Mediana Co., Ltd.**

132, Donghwagongdan-ro,

Munmak-eup, Wonju-si, Gangwon-do, Korea

Tel: (82) 2 542 3375 (82) 33 742 5400

Fax: (82) 2 542 7447 (82) 33 742 5483

Revised Date: 2020-01

Part Number-Revision: A7659-0

Copyright © 2020 All rights reserved.

CE
2797



Directive

- Copyright law allows no part of this instruction manual to be reproduced without permission.
- The contents of this manual are subject to change without notice.
- The contents of this manual should be correct. If, for some reason, there are any questionable points, please do not hesitate to contact our service center.
- The manual will be replaced if any pages are missing or collation is incorrect.

Warranty

- Device failure or damage related to the following situations during the guarantee period is not covered by this warranty:
 - Installation, transfer installation, maintenance and repairs by any person other than an authorized Mediana. employee or technician specified by Mediana.
 - Damage sustained to the Mediana product(s) caused by product(s) from another company excluding products delivered by Mediana.
 - Damage – caused by mishandling and/or misuse – is the responsibility of the user.
 - Maintenance and repairs utilizing maintenance components that are not specified by Mediana.
 - Device modifications or use of accessories not recommended by Mediana.
 - Damage caused by accidents or natural disasters (earthquakes, flooding, etc.).
 - Damage resulting from usage where caution statements and operating instructions shown in this manual have not been followed.
 - Damage due to neglect of specified maintenance checks.
- This warranty only covers the hardware of the HeartOn A16. The warranty does not cover the following selections:
 - Whatever damage or loss results from the attachment of accessories or their operation.
 - In the event of a defect in the product, contact our sales outlet or EU representative as noted on the back cover.
- The HeartOn A16 conforms to the EMC standard IEC60601-1-2.

Note: It is possible that using in the vicinity of mobile phone may result in disruption in the AED operation.

Revision History

The documentation part number and revision number indicate its current edition. The revision number changes when a new edition is printed in accordance with the revision history of the documentation. Minor corrections and updates which are incorporated at reprint do not cause the revision number to change. The document part number changes when extensive technical changes are incorporated.

Trademark

Product brand names shown in this manual are likely to be the trademark or registered trademark of the company concerned.



CONTENTS	i
SAFETY INFORMATION	1
General Safety Information	1
Warning	1
Cautions	3
INTRODUCTION	5
Intended Use for the AED	5
Where can it be used?	5
Who can use it?	5
Local Requirements	5
Device Tracking	5
About This Manual	6
Education	6
Identifying the AED Configurations	7
DESCRIPTION OF THE AED	9
Top and Right Panel Components	9
Rear Panel Components	10
Symbols and Labels	11
SETTING UP THE AED	13
Unpacking and Inspection	13
List of Components	13
Soft Carry Case	14
SD card	14
Event Data	14
Infrared communication port	15
Setting up the AED	16
Temperature status	16
Pads status	16
BATTERY OPERATION	19
Operating the AED on Battery Power	19
Battery Status Indication	21
Self Test	22
CPR FEEDBACK MODULE OPERATION	25
Operating the CPR Feedback Module	25
USING THE AED	27
AHA/ERC guidelines (Rescue protocol)	27
Pre Defibrillation Action	29
Operating the AED	29
Operation of HeartOn A16	32
Performing CPR	36
Note User and Bystander Safety	38
MAINTENANCE	39
Recycling and Disposal	40
Returning the AED and System Components	40
Service	40
Periodic Safety Checks	40
Cleaning	41
Battery Maintenance	41
Pads Maintenance	41
CPR Feedback Module Maintenance	42
The AED Maintenance	43
TROUBLESHOOTING	45
General	45
Corrective Action	45
EMI (Electromagnetic Interference)	46
Obtaining Technical Assistance	46
GLOSSARY	47
SPECIFICATION	49
Defibrillation Electric Shock	49



ECG	49
Indication	49
Physical	49
Environmental Conditions.....	50
Self Test	50
Data Backup and Communication	50
Expected Service Life.....	50
Accessories Specifications	51
Defibrillation waveform	52
ECG Analysis Performance.....	54
Compliance.....	55
Manufacturer's Declaration	56

Figures

<i>Figure 1. HeartOn A16: Top and Right Panel Components.....</i>	<i>9</i>
<i>Figure 2. HeartOn A16: Rear Panel Components.....</i>	<i>10</i>
<i>Figure 3. Removing the battery.....</i>	<i>19</i>
<i>Figure 4. Inserting the battery</i>	<i>20</i>
<i>Figure 5. Removing the battery protection sticker.....</i>	<i>20</i>
<i>Figure 6. Place the Adhesive Pad.....</i>	<i>25</i>
<i>Figure 7. Replacing the CPR Feedback Module.....</i>	<i>26</i>
<i>Figure 8. Patient mode switch Button</i>	<i>30</i>
<i>Figure 9. Pads disconnect icon (Chest type-A16-DS, A16-DF)</i>	<i>31</i>
<i>Figure 10. Pads disconnect icon (Icon type-A16-GS, A16-GF)</i>	<i>31</i>
<i>Figure 11. Action Icon – Step 1</i> <i>(Left: Chest type-A16-DS, A16-DF(Ⓟ), Right: Icon type-A16-GS, A16-GF(Ⓟ)).....</i>	<i>32</i>
<i>Figure 12. Pads Placement</i>	<i>32</i>
<i>Figure 13. Action Icon – Step 2</i> <i>(Left: Chest type-A16-DS, A16-DF(Ⓞ), Right: Icon type-A16-GS, A16-GF (Ⓞ)).....</i>	<i>33</i>
<i>Figure 14. Action Icon – Step 3</i> <i>(Left: Chest type-A16-DS, A16-DF (Ⓞ, Ⓟ), Right: Icon type-A16-GS, A16-GF(Ⓞ, Ⓟ)</i>	<i>34</i>
<i>Figure 15. Action Icon – Step 4</i> <i>(Left: Chest type-A16-DS, A16-DF(Ⓢ), Right: Icon type-A16-GS, A16-GF(Ⓢ)).....</i>	<i>35</i>
<i>Figure 16. Pads status icon.....</i>	<i>41</i>
<i>Figure 17. Use by date of Pads.....</i>	<i>43</i>

Tables

<i>Table 1. HeartOn A16 Panel Components</i>	<i>10</i>
<i>Table 2. Panel and Label Symbols.....</i>	<i>11</i>
<i>Table 3. Accessories.....</i>	<i>13</i>
<i>Table 4. The battery Status Icon.....</i>	<i>21</i>
<i>Table 5. Electromagnetic Emissions (IEC60601-1-2)</i>	<i>56</i>
<i>Table 6. Electromagnetic Immunity (IEC60601-1-2).....</i>	<i>56</i>
<i>Table 7. Electromagnetic Immunity (IEC60601-1-2) (continued).....</i>	<i>57</i>
<i>Table 8. Recommended Separation Distances.....</i>	<i>58</i>
<i>Table 9. Immunity to proximity fields from RF wireless communications equipment (IEC 60601-1-2).....</i>	<i>59</i>
<i>Table 10. Cables (IEC60601-1-2)</i>	<i>59</i>



SAFETY INFORMATION

General Safety Information

This section contains important safety information related to general use of the HeartOn A16. Other important safety information appears throughout the manual. The HeartOn A16 will be referred to as the AED throughout this manual.

Before use, carefully read operator’s manual, accessory directions for use, all precautionary information and specifications.

Warning

Warnings alert you to potential serious outcomes (death, injury, or adverse events) to the patient or user.

⚠ WARNING	As a user of an AED it is essential that you inform Mediana of any incident where your AED is suspected to have caused a death, serious injury or illness. If you have any suspicions that this is the case inform Mediana directly or through your local distributor.
⚠ WARNING	The AED must be used by a person trained in CPR and the use of AED. The qualification for the usage of AED should follow the local laws.
⚠ WARNING	The AED has the capability to deliver therapeutic electrical shocks. The shock can cause serious harm to either operators or bystanders. Caution must be taken to ensure that neither the operators nor bystanders touch the patient when a shock is to be delivered.
⚠ WARNING	The AED has not been evaluated or approved for use in hazardous locations as defined in the National Electrical Code (Articles 500-503). In accordance with the IEC/EN 60601-1 Classifications, the AED is not to be used in the presence of flammable substance/air mixtures.
⚠ WARNING	The AED has been designed to work on unresponsive, non-breathing and pulseless* patients. If the patient is conscious or breathing and regain a pulse, do not use the AED to provide treatment. (*checking pulse corresponds to health care provider)
⚠ WARNING	Touching the patient during the analysis phase of treatment can cause interference with the diagnostic process. Avoid contact with the patient and keep the patient as motionless as possible while ECG analysis is being carried out. The AED will instruct you when it is safe to touch the patient.
⚠ WARNING	Always stand clear of patient when delivering treatment. Defibrillation energy delivered to the patient may be conducted through the patient’s body and cause a lethal chock to those touching the patient.
⚠ WARNING	It has been determined that the AED is safe to use in conjunction with oxygen mask delivery systems. However, due to the danger of explosion it is strongly advised that the AED should not be used in the vicinity of explosive gases. This includes flammable anesthetics, concentrated oxygen and gasoline.
⚠ WARNING	The identical pad is used for both Adult and Pediatric. The Adult mode must be used on patients older than 8 years old. The Pediatric mode must be used on patients between 1 and 8 years or less than 25 kg (55lb). Do not use the AED on patient younger than 1 year old.



⚠ WARNING	Proper placement of the pads is critical. Strict observance of pad positioning instructions, as indicated on the labeling and in training, is essential. Care must be taken to ensure pads are adhered to the patients' skin properly. Air pockets between the adhesive pad and skin must be eliminated. Failure in pad adhesion may hinder effectiveness of therapy or cause excessive skin burns to the patient if a shock is applied. Reddening of the skin may appear after use, this is normal.
⚠ WARNING	The battery of AED is not rechargeable. Do not try to recharge, open, crush, or burn the battery, or it may explode or catch fire.
⚠ WARNING	Do not allow the pads to contact other electrodes or metal parts that are in contact with the patient. Such contact can cause patient skin burns during defibrillation and may divert defibrillating current away from the heart.
⚠ WARNING	Pay attention to possibility of contact with conduction part of electrode, lead line, cable connector, other patient installation part for patient safety.
⚠ WARNING	Do not use this AED near or within puddles of water.
⚠ WARNING	Do not reuse electrodes to many patients.
⚠ WARNING	Use the AED or accessories only as described in this manual. Improper use of the AED can cause death or injury.
⚠ WARNING	Do not use or place the AED in service if the status indicator of AED displays "X". Contact your local distributor or Mediana service team.
⚠ WARNING	Keep batteries dry and away from any heat sources (including direct sunlight). If you see any damage or leakage, do not allow the liquid to come in contact with your skin or eyes. If contact has been made, wash the affected area with plenty of water and seek medical advice immediately.
⚠ WARNING	The AED contains an automatic disarm of the stored energy. If the operator has not delivered the energy to a patient, an internal timer will disarm the stored energy. This stored electrical energy can potentially cause death or injury if discharged improperly. Follow all instructions in this manual.
⚠ WARNING	Check the status Indicator periodically. If the status Indicator displays "X", a problem has been detected. Manage it for no problem in case of emergency.
⚠ WARNING	As with any medical equipment, carefully route patient cabling to reduce the possibility of patient entanglement or strangulation.



Cautions

Caution statements identify conditions or practices that could result in damage to the equipment or other property.

⚠ CAUTION	The AED may not operate properly if it is operated or stored at conditions outside the ranges stated in this manual.
⚠ CAUTION	The AED was designed to be sturdy and reliable for many different use conditions. However, handling the AED too roughly can damage it or its accessories and will invalidate the warranty. Check the AED and accessories regularly for damage, according to directions.
⚠ CAUTION	Before delivering a shock, it is important to disconnect the patient from non-defibrillation protected electronic devices, such as blood-flow meters, that may not incorporate defibrillation protection. In addition, make sure the pads are not in contact with metal objects such as a bed frame or stretcher.
⚠ CAUTION	The pads pouch shall not be opened until immediately prior to use.
⚠ CAUTION	Do not use or place the AED in service until you have read the AED Operator's manual.
⚠ CAUTION	Do not use or stack the AED with other equipment. If the AED is used or stacked with other equipment, verify proper operation prior to use.
⚠ CAUTION	Handling or transporting the patient during ECG analysis can cause incorrect or delayed diagnosis. If the AED gives a SHOCK ADVISED prompt during such handling or transport, stop the vehicle and keep the patient as still as possible for at least 15 seconds before pressing the Shock button, to allow the AED to reconfirm the rhythm analysis.
⚠ CAUTION	Periodic checks of this AED must be undertaken to ensure among other things that the AED is not damaged in any way.
⚠ CAUTION	The pads are a single use item and must be replaced after each use or if pouch that seals pads has been broken/compromised in any way. If damage is suspected the pads must be replaced immediately.
⚠ CAUTION	Do not use training pads with this AED.
⚠ CAUTION	Carefully observe pacemaker patients. Patient history and physical examination are important in determining the presence of implanted pacemaker. Patient pacemakers may reduce the sensitivity of the AED analysis and errors in detecting shockable rhythms.
⚠ CAUTION	If the pads are attached to the chest firmly, the AED can analyze the exact ECG and prevent the skin burns. But if the pads are overlapped on the patient chest, the pads will not deliver defibrillation energy properly.
⚠ CAUTION	If the voice recording option is applied, the HeartOn A16 records the surrounding sound. The voice prompt, "Audio recording in progress", is played.

**MEDIANA
HEARTON
AED A16**

Automated External Defibrillator





INTRODUCTION

Mediana provides you with a fully configurable AED system to allow you to comply with your chosen SCA treatment protocol. Our current AED is configured to be compliant with the 2015 version of the AHA/ERC guidelines on Cardiopulmonary Resuscitation (CPR) and Emergency Cardiovascular Care (ECC). It is recommended to be trained in the appropriate version of the AHA/ERC guidelines and the use of your AED configuration. Contact Mediana or your authorized Mediana distributor for further information.

Intended Use for the AED

The AED is intended to be used to treat someone who is unresponsive, non-breathing and pulseless for the adult and pediatric in all area of a hospital, pre-hospital, public access, alternate care and home healthcare environment. AED is designed to easy to use.

Note: The intended patient populations are adult and pediatric (between 1 and 8 years or less than 25 kg (55lb)) can be treated with the appropriate pads.

Note: If you have concerns about your health or an existing medical condition, talk to your doctor. A defibrillator is not a replacement for seeking medical care.

Where can it be used?

The intended environment to use the AED includes home healthcare, public space and hospital. The public space is a social space that is generally open and accessible to people. Roads (including the pavement), public squares, parks, subway station, government buildings, beaches, public libraries, privately owned buildings or property opened to public/visible from sidewalks and any shared spaces of automobiles and other vehicles are typically considered public space. Hospital use typically includes areas such as general care floors, operating rooms, special procedure areas, intensive and critical care areas within the hospital. Hospital-type facilities include physician office-based facilities, sleep labs, skilled nursing facilities, surgical centers, and sub-acute care centers.

Who can use it?

You cannot use the AED to treat yourself. The AED talks the user through each step of treating someone who is in SCA. However, anyone who might use the AED should review the training materials that come with it or contact your local authorized supplier or Medical technical support, and should be trained in cardiopulmonary resuscitation (CPR). Responding to SCA may require the user to kneel.

Local Requirements

Check with your state health department to see if there are any local or state requirements about owning and using an AED. You can find contact local supplier or Mediana technical support for learning about your country or state.

Device Tracking

This AED may be subject to tracking requirements by the manufacturer and distributors per local regulation. If there are tracking requirements in your local, please notify your local distributor when the AED has been sold, donated, lost, stolen, exported, or destroyed.



About This Manual

This manual explains how to set up and use the AED.

Read the entire manual including the *Safety Information* section, before you operate the AED.

Education

An acute heart attack is an emergency situation that requires an emergency treatment. First-aid measures can be performed without physician action due to the nature of acute heart attack. We encourage potential users who are expected to use AEDs to be trained in CPR and AED usage for accurate diagnosis. It is also recommended that user be educated or retrained with the latest content in accordance with general retraining or the recommendation of the training institution. If the person expecting to use the AED is not trained in the above, please contact your local distributor or Mediana who can provide the training. Information on authorized local training organizations can also be found in relevant departments of the government.

Note: Check the surrounding environment to make sure it conforms to the environmental conditions mentioned in this manual. If the AED is used in an environment other than the environment mentioned in this manual, there may be a problem with stability.



Identifying the AED Configurations

The following table identifies the AED configurations and how they are indicated. The Reference number and serial number are located on the bottom of the AED.

Model Name	Reference No.	Description
HeartOn A16-DS	A16M-DS-0E	A16-DS Standard
	A16M-DS-VQ-0E	A16-DS Standard + Voice recording + Pads quality
	A16M-DS-CQ-0E	A16-DS Standard + Pads quality + CPR feedback
	A16M-DS-VCQ-0E	A16-DS Standard + Voice recording + Pads quality + CPR feedback
HeartOn A16-DF	A16M-DF-0E	A16-DF Standard
	A16M-DF-VQ-0E	A16-DF Standard + Voice recording + Pads quality
	A16M-DF-CQ-0E	A16-DF Standard + Pads quality + CPR feedback
	A16M-DF-VCQ-0E	A16-DF Standard + Voice recording + Pads quality + CPR feedback
HeartOn A16-GS	A16M-GS-0E	A16-GS Standard
	A16M-GS-VQ-0E	A16-GS Standard + Voice recording + Pads quality
	A16M-GS-CQ-0E	A16-GS Standard + Pads quality
HeartOn A16-GF	A16M-GF-0E	A16-GF Standard
	A16M-GF-VQ-0E	A16-GF Standard + Voice recording + Pads quality
	A16M-GF-CQ-0E	A16-GF Standard + Pads quality

Note: A16-DS Standard = A16 (Semi auto) + Multilingual voice prompt + Chest type
 A16-DF Standard = A16 (Fully auto) + Multilingual voice prompt + Chest type
 A16-GS Standard = A16 (Semi auto) + Multilingual voice prompt + Icon type
 A16-GF Standard = A16 (Fully auto) + Multilingual voice prompt + Icon type

Note: The alphabet "E" can be added as the last digit of reference number in accordance with the region.



Features for the AED

Physical/Mechanical

The AED is an automated external defibrillator (AED) used for the fast delivery of defibrillation electric shock therapy which can be battery-operated.

Electrical

The AED has a battery which is detachable and non-rechargeable.

Display

The indication is LED indicator that flashes red LED under the relevant action icon.

Auxiliary Input/Output(s)

The AED provides Infrared communication port, SD card ports.



DESCRIPTION OF THE AED

Top and Right Panel Components



<Chest Type · A16-DS, A16-DF>

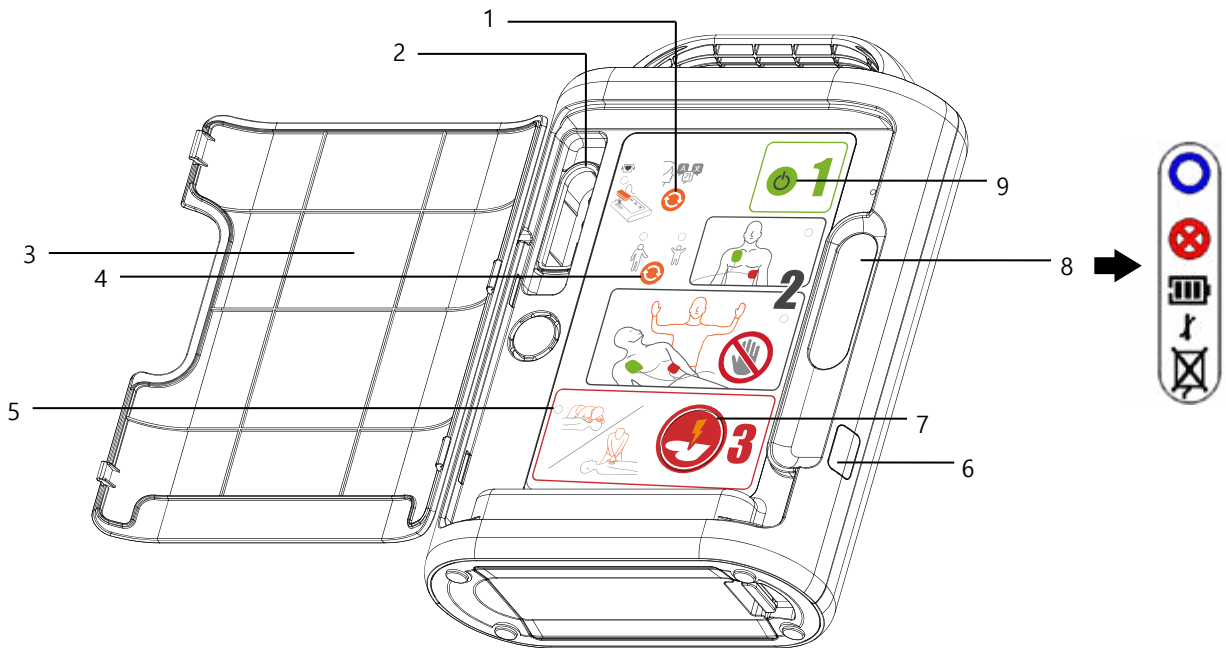

<Icon Type · A16-GS, A16-GF>

Figure 1. HeartOn A16: Top and Right Panel Components



Rear Panel Components

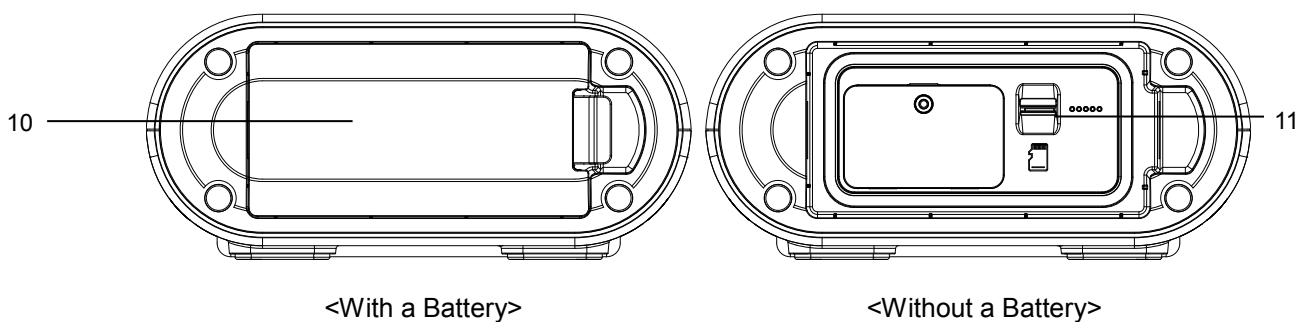

Figure 2. HeartOn A16: Rear Panel Components

Table 1. HeartOn A16 Panel Components















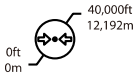

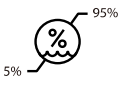

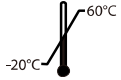
1	Select language button	User can select the desired language among three different languages by pushing the select language button.
2	Pad connector	Pad connector links the pads.
3	Cover	Cover is used to protect the action icon, the patient mode switch button, the power button, the select language button and the shock button.
4	Patient mode switch button	After user distinguish the patient according to patient type, select the patient mode between adult and pediatric patient mode by pushing the patient mode switch button.
5	Indicator LED	The indicator LED flashes red LED near the relevant action icon.
6	Infrared communication port	Infrared communication port is used to communicate with the PC.
7	Shock button (Semi-Auto Only)	When preparation for electric shock is completed, the shock button will flash. Push the Shock button and then the AED delivers the shock.
8	Status indicator	Status indicator displays the AED status, the temperature status, the battery status and the PADS status.
9	Power button	Power button is used to On/Off the power.
10	Battery	User can remove or reseal the battery.
11	SD card port	SD card is used to save the data and update the AED software.



Symbols and Labels

The following symbols may be used in this manual, related documentation, or appear on system components or packaging.

Table 2. Panel and Label Symbols

Symbols	Description	Symbols	Description
	Ready to use		Do not reuse
	Not ready to use		CE mark
	Battery status		Environmental shipping/storage atmospheric pressure limitations
	Temperature status		Environmental shipping/storage humidity limitations
	Contains no latex		Environmental shipping/storage temperature limitations
	Use by date		Fragile-handle with care
	Follow instructions for use		This way up
	Manufacturer		Keep dry
	Date of manufacture		Type CF – Defibrillator proof
REF	Reference number	IP55	Dust and water resistance
SN	Serial number		Disposal instructions
	Pads status		

**MEDIANA
HEARTON
AED A16**

Automated External Defibrillator





SETTING UP THE AED

⚠ WARNING	To ensure accurate performance and prevent AED failure, do not expose the AED to extreme moisture, including direct exposure to rain. Such exposure may cause inaccurate performance or AED failure. Refer to Specification section.
⚠ WARNING	Using damaged or expired AED or accessories may cause the AED to perform improperly, and/or injure the patient or the user.

Unpacking and Inspection

The AED is shipped in one carton. Examine the AED including the accessories carefully for evidence of damage. Do not use damaged equipment. Refer to the Maintenance section for instructions on returning damaged items. Ensure all potential users are suitably trained.

Note: Inspect the packaging of accessories to ensure integrity of seals and validity of use by date.

List of Components

The following items are accessories in the package. Optional accessories may be ordered if needed. Contact qualified service personnel or your local supplier for pricing and ordering information.

Table 3. Accessories

Standard Accessories	Qty
HeartOn A16	1
Operator's manual	1
Automated External Defibrillator Pads (1.8m)	1
Non-rechargeable LiMnO ₂ Battery (15V, 3000mAh)	1
Optional Accessories	Qty
HeartOn AED Event Review Software	-
HeartOn AED Event Review Software - User Guide	-
Infrared communication adaptor	-
Mini USB cable	-
Soft Carry Case	1
Micro SD card	1
CPR Feedback Module *Only when CPR feedback option is installed.	1
Adhesive Pad *Only when CPR feedback option is installed.	5
Automated External Defibrillator Pads (1.8m / for pads quality) *Only when Pads quality option is installed.	1
Automated External Defibrillator Pads (1.8m / for pads quality + CPR Feedback) *Only when CPR feedback option is installed.	1
Recommended Accessories	Qty
Scissors – for cutting the victim's clothed if needed	-
Disposable gloves – to protect the user	-
A disposable razor – to shave the chest if hair prevents good pads contact	-
A pocket mask or face shield – to protect the user	-
A towel or absorbent wipes – to dry the victim's skin for good pads contact	-



Soft Carry Case

⚠ CAUTION The AED should be protected by the soft carry case during the move.

The soft carry case has been designed to allow the AED not to move in the soft carry case by using the AED own handle. The user can check the status indicator of AED without having to open the carry case. The paper with contact information of the nearest emergency medical services can be inserted to the clear cover. The soft carry case has the pocket on the rear side of the carry case for the manual and spare pads, spare battery and the CPR Feedback module (option).

SD card

The SD card is inserted into the SD card port on the AED's bottom panel as described below. The SD card is used to record the history of the AED performance and to update the AED firmware. The recorded history in the SD card can be checked by the HeartOn AED Event Review Software. If you want to use the SD card to use the HeartOn AED Event Review Software or to update the AED firmware, please contact qualified service personnel or your local supplier.

1. When the AED is turned on, turn off the AED by pushing the power button.
2. Remove the battery from the bottom of the AED.
3. Check the proper orientation of the SD card and insert the SD card into the SD card port.
4. Reseat the battery in the bottom of the AED.
5. If necessary to update the AED through SD card, turn on the AED by pushing the power button.
6. After complete the update, automatically turn off itself. Close the cover again.

Note: Only micro SD cards supplied by Mediana should be used.

Event Data

The event data are stored in the SD card. The event data can be read by HeartOn AED Event Review Software.

Note: When the AED does not have an SD card in it or your SD card is unreadable, corrupted, damaged or has some error, the event data are stored in the internal memory as the LED indicator and buzzer sound will go on.

- In case the SD card has a problem, buzzer will sound 4 times after the CPR Action Icon LED lights up. {Repeat twice}

AED records up to 4 times (1 time: from power ON to power OFF) of operation data in the flash memory. From the fifth operation data will be stored after the oldest data is deleted.

The maximum data that can be stored at one time is ECG (6488 sec), HR (37 times of shock advised, 74 times of no shock advised), Trend (37 times of shock advised, 74 times of no shock advised), and Temperature (36 times). If any of the above four data is full during a progress once, the operation data is no longer stored.



The event data which are stored in internal memory can be viewed after downloading via SD card in accordance with the following procedure.

1. Run the Notepad in Windows. The Notepad window appears with a blank document open.
2. Save this empty file in Notepad and name it 'Import Internal Data.txt'.
3. Open the SD card on PC.
4. In the SD card, create the directory folder and name it 'Update'.
5. Copy the carried out 'Import Internal Data.txt' file into the 'Update' directory folder.
6. Remove the battery from the AED and insert the SD card supplied by Mediana to SD card port which is located at bottom side of the AED.
7. Reseat the battery and the AED is turned on, the event data are downloaded to SD card automatically.
8. The downloaded event data can be viewed via the HeartOn AED Event Review Software.

Note: When downloading the stored event data in internal memory to SD card, the event data which are stored in internal memory will be deleted.

Note: If the SD card has some error, the AED can recognize that the SD card is not inserted.

Note: Event data in SD card could be used for further clinical assessment. Please make sure that event data are securely saved in any of storage format when event data is accessed by the HeartOn AED Event Review Software or is uploaded to PC.

Note: It is strongly recommended that the event data in SD card should be uploaded to PC and should be reset before the event data reach 10000 events in SD card by periodically checking the HeartOn AED Event Review Software, in order to avoid losing any of event data because the device is designed to stop saving event data when it reaches 10000 events in SD card and there is no indication in the device of reaching 10000 events in SD card.

Note: If you require any additional information, please refer to HeartOn AED Event Software User guide.

Infrared communication port

Infrared communication port provides wireless communications from the AED to a PC through the Infrared communication data download cable and IR communication adaptor which is connected to PC. The Infrared communication is used to transfer information and to connect to service mode. If you want to use Infrared communication port, please contact qualified service personnel or your local supplier.



Setting up the AED

⚠ WARNING	Use only Mediana-approved and specified parts, accessories, optional parts, consumables, and components. Use of unauthorized accessories may cause the AED to operate improperly and provide false measurements. Follow all labeling instructions on the defibrillation pads and the battery.
⚠ WARNING	Always follow your facility’s infection control procedures and applicable regulations when disposing of anything that has been used on patients.
⚠ CAUTION	Do not open the pads from packaging previously until the time of emergency use when pads are used for patient.
⚠ CAUTION	The pads should be connected to the AED as preparation for emergency circumstances.
⚠ CAUTION	The AED should not be used or loaded with other equipment. If it is necessary, the AED should be observed to verify normal operation before using.
⚠ CAUTION	Do not use the expired pads.
⚠ CAUTION	Do not reuse the pads. Reuse can lead to potential cross infection, improper performance of the device, inadequate delivery of therapy, and/or injury to the patient or operator.

Temperature status

Temperature status displays the following description.

- If the self-test is implemented in out-of-range for environmental operation condition, the status indicator ‘O’ will be displayed.
- If the self-test is implemented in out-of-range for environmental operation condition above 5 times, the status indicator ‘X’ will be displayed.
- When the AED with displaying status indicator ‘O’ is turned on in out-of-range for environmental operation condition.

Note: When the AED with displaying status indicator ‘X’ and temperature status is turned on in specified environmental operation condition, will operate properly.

Note: When the AED is turned on in the inappropriate environmental operation condition, temperature status will be blink.

Note: If the AED is placed in out-of-range value for environmental operation condition for long time, it will be longer than usual to recognize the temperature. It is recommended that AED should be stored in environmental operation condition described in this manual.

Pads status

Pads status displays the following description.

- If the pads are disconnected with the AED, the pads status will be displayed.
- For the AED with the pads quality feature, the pads status will be displayed if there is a problem with the pad connected to the AED. (expiration of the pads, expired pads, damaged pads or recommended replacement of the pads)

Note: If the pads are normally connected to the pads quality enabled AED but the pad status indicator is showing, the pads need to be replaced.

Note: If user replaces the pad connected to the pads quality enabled AED and perform a self test, the pads status indicator will be displayed or not according to the pads status.



Install 1

1. Install the battery to the AED.
2. The status indicator of the AED will display “X” and then operate the battery insertion self test.
3. When the battery insertion self test is completed normally, voice prompt “Unit ok” will be emitted and the status indicator will be changed from “X” to “O”.
4. Take out the pads.
5. Open the cover of the AED.
6. Plug defibrillation pads into the pads connector of the AED.
7. (option) Connect the CPR Feedback sensor to the AED.
8. Check the voice prompt “Unit ok” is emitted and the status indicator is “O” by pushing the power button.
9. Turn off the AED by pushing the power button.
10. Close the cover of the AED.

Note: When pads are already connected to the AED in packaging, take out the AED from the packaging and then move to Install 2.

Note: The pads should be connected to the AED as preparation for emergency circumstances.

Note: If there is a CPR Feedback Module, connect the CPR Feedback Module to the AED as preparation for emergency circumstances.

Note: Do not open defibrillation pads protective packaging until the time of emergency use when they are applied to a patient.



Install 2

Check that the AED is working optimally.

1. (option) Connect the CPR Feedback sensor to the AED.
2. Turn on the AED by pushing the power button, ensure that you can hear the voice prompt.
3. Change the Patient mode by pushing Patient mode switch button, ensure that you can hear the proper voice prompt and see the proper indicator lights up depending on the patient mode setting.
4. The recording option is set “On”, ensure that you can hear the voice prompt. (Option)
 - “Unit ok”
 - “Adult mode” or “Pediatric mode”
 - “Audio recording in progress” (Option)
5. Ensure you can see the status indicator displays “O”.
6. Turn off the AED by pushing the power button.
7. Close the Cover with placing the defibrillation pads inside the AED.

Note: If there is a CPR Feedback Module, connect the CPR Feedback Module to the AED as preparation for emergency circumstances.

Note: When the battery is replaced with the AED, self test will be automatically started. After completing the self test, ensure that you can hear the voice prompt “Unit ok” and then check the AED is turned off.

Install 3

Place the AED into its Soft Carry Case.

Install 4

Put into a storage or safe visible location.

Note: Storage differs in some countries. Ask qualified service personnel or your local supplier.

The AED should be kept in a convenient central area. Place it near a telephone so that the rescuer can call Emergency Medical Services and retrieve the AED without wasting time. Some important points to remember when storing:

- Store the AED in a suitable location for easy access.
- Do not lock the location where the AED is being placed.
- Store the AED in a clean and dry environment.
- Install the AED in the environmental operation condition described in this manual.

Make all necessary arrangements to ensure that the AED is accessible at all times. Inform any possible users of the location of the AED.



BATTERY OPERATION

⚠ WARNING	Test battery regularly, when the voltage of battery is very low. A battery that does not pass its test might shut down expectedly.
⚠ WARNING	Do not use a battery that is damaged, leaking, or wet.
⚠ WARNING	Do not use or store the battery in a place that may be exposed to high temperature.
⚠ CAUTION	To ensure the availability of adequate power during an emergency, keep a new spare battery pack with the AED at all times.
⚠ CAUTION	When the voltage of the battery is very low, it is a possibility of not operating.
⚠ CAUTION	If the battery shows any signs of damage, leakage or cracking, it must be replaced immediately.
⚠ CAUTION	Discarded batteries may explode during incineration. Dispose used batteries properly. Do not dispose of batteries in refuse containers.
⚠ CAUTION	Check battery capacity regularly. Replace the new battery if you need.
⚠ CAUTION	Except for inspection, if the AED is frequently turned on, turned off or discharged, battery standby life will not last longer than the intended standby life by manufacturer.

Operating the AED on Battery Power

The AED has an installed non-rechargeable battery. The battery status appears on the status indicator when the AED is on battery power.

Replacing the battery

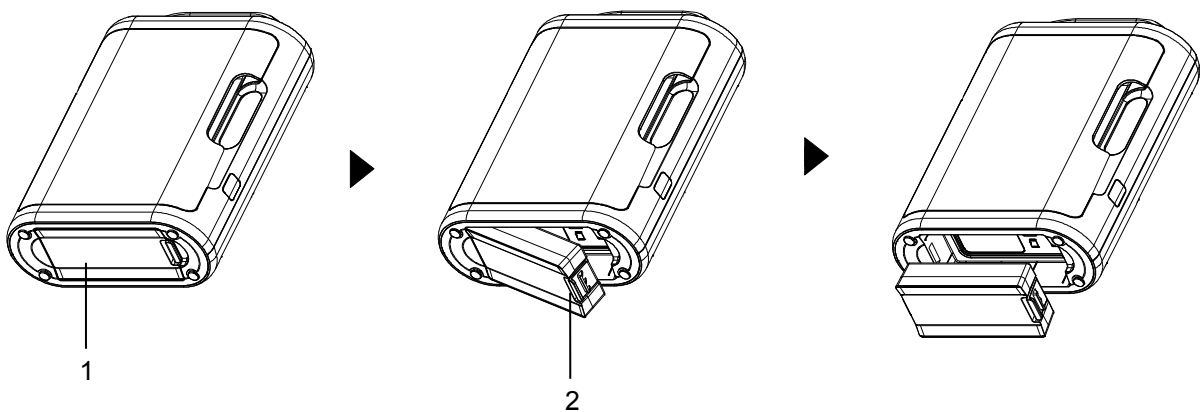

1. Battery
2. Battery release button

Figure 3. Removing the battery

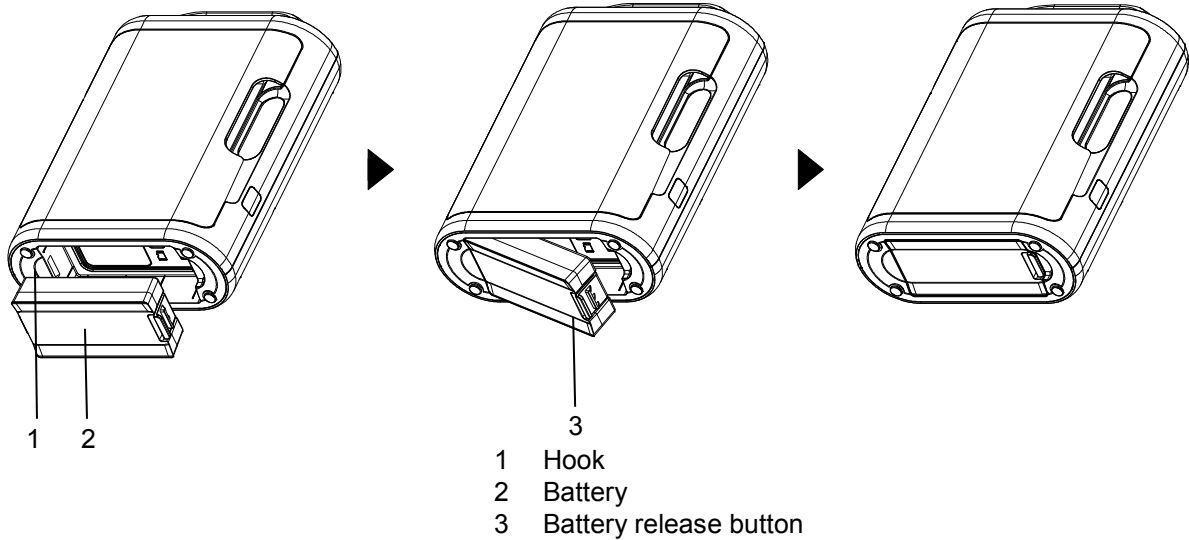

Figure 4. Inserting the battery

1. Pull down the battery while pushing the battery release button, then disconnect the battery as shown in the Figure 3.
2. Prepare the new battery, then connect the battery and AED by using the hook as shown in the second figure of the Figure 4.
3. When the connection part is fastened properly, slide the side of the battery with the release button into the AED until the click sound is emitted as shown in the third of the Figure 4.

The AED uses the non-rechargeable battery. The AED cannot operate with the battery that has been completely discharged. Before turning on the AED with a battery that has been completely discharged, first replace the battery. When the new battery is installed, the AED is automatically turned on and then starts the battery insertion self test. After the battery insertion self test is completed, the AED may then be powered off.

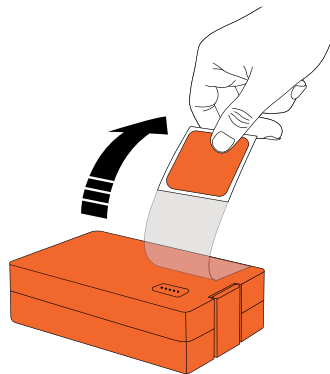

Figure 5. Removing the battery protection sticker

Note: For new batteries, remove the battery protection sticker before inserting the battery as shown in the Figure 5.



Battery Status Indication

A new battery's life time is as below;

- Shelf life (in the original packaging): 2 years from manufacture date when stored and maintained according to direction provided in the operator's manual.
- Standby life (inserted in the AED): 5 years from manufacture date when stored and maintained according to direction provided in the operator's manual.
- Discharge: A minimum of 200 shocks (excepting the CPR period for shocks) or more than 6 hours of operating time under the ambient temperature at 20 °C.





If shock is delivered or shockable rhythm analysis is conducted once or more, the standby battery life would get shorter than the life time specified in above.

After installing the new battery in the AED then the AED is on standby at least one day, the discharge condition may not meet that mentioned above.

Note: Due to the physical dimensions of the battery compartment, only batteries supplied by Mediana should be used. Using other types of replacement batteries may result in damage to the AED and void the limited warranty.

When operating on batteries, the battery status in the status indicator indicates the battery condition. See Table 4.

Table 4. The battery Status Icon

Battery Status Icons	Battery Status
	full charged (≤ 200 shocks or maximum 6 hours of operating time)
	
	used (≤ 9 shocks)
	discharged (no shock)

If you hear the voice prompt “low battery, insert fresh battery” when the AED is turned on or is being used, the AED would be available 9 shocks. If the last bar of the battery indicator is invisible, buzzer would be sounded 2 times and then turned off automatically.



Self Test

Before using the AED, confirm that the AED is working properly and is safe to use as described below.

⚠ WARNING	If the self test is not completed successfully, do not try to use the AED.
⚠ CAUTION	When power is applied, the AED automatically starts the self test, which tests the AED circuitry and functions. During performing Power On Self Test(POST), confirm that the AED status indicator turns on. If the AED status indicator does not function properly, do not use the AED. Instead, contact qualified service personnel or your local supplier.

Performing Power On Self Test (POST)

1. Remove the cover of the AED.
2. Turn on the AED by pushing the Power button.
3. The AED automatically starts the Power On Self Test (POST).
4. If the AED detects an error during POST, the status indicator will display “X”. Contact qualified service personnel or your local supplier for assistance.
5. Upon successful completion of the POST, the AED sounds voice prompt “Unit ok” and the status indicator displays “O”.
6. Turn off the AED by pushing the Power button.
7. Close the cover of the AED.

Automatic Self Test

The AED includes an automatic self test which is performed on a daily basis. The self test will run automatically and requires no user interaction. If there is an error, the status indicator displays “X”.

The self test will test your AED and ascertain if its basic functions are running.

- Daily self test : MCU and Memory(RAM, ROM) integrity, Battery capacity, SD card connection, Ambient temperature, Patient body impedance, speaker, Status of the Pads.
- Weekly self test : Waveform delivery circuit low (about 7J) energy test, ECG circuit test in addition to the daily self test.
- Monthly self test : Waveform delivery circuit high (50J) energy test in addition to the weekly self test.



Note: When the battery is discharged, the status indicator will display “X”. Even if the new battery is replaced, the status indicator still displays “X”. Please contact qualified service personnel or your local supplier.

Note: Self test is not able to determine if the battery currently inserted in the AED are within their use by date. User must remember to check the use by date on the battery and standby life on the battery regularly.

Note: During the self test, the temperature status is displayed when the ambient temperature is out of range.

Note: The AED that is activated the record function will do the self test for record function.

Note: AED will always do the self test for the pads connection. If the pads are disconnected to the AED, the pads status indicator is displayed.

Note: The AED that is activated the pads quality function will do the self test for use by date of the pads, whether used, dryness and damage.

Note: The AED that is activated the CPR Feedback function will do the self test for CPR Feedback function.

Battery Insertion Self test

When the battery is replaced, the AED automatically starts the battery insertion self test. After battery insertion self test is completed, the AED sounds voice prompt “Unit ok”, the status indicator displays “O” and power of the AED is automatically turned off. If the battery insertion self test is not completed successfully, the AED sounds voice prompt “Unit fail” and the status indicator displays “X”. If the AED does not function properly, do not use the AED. Instead, contact qualified service personnel or your local supplier.

You can also skip the battery insertion self test, try following procedure.

- Open the cover of the AED, and pushing the power button.

Note: Self test is not able to determine if the battery currently inserted in the AED are within their use by date. User must remember to check the use by date on the battery and standby life on the battery regularly.

Note: The AED that is activated the pads quality function will do the self test for use by date of the pads, whether used, dryness and damage. User must remember to check the pads condition regularly.

Note: The internal battery is used to perform self test and real time clock and it could operate for at least 10 years. However, please note that this period could vary slightly depending on storage condition and use of environment. If the operating time has passed, the battery status disappears and “X” appears on the status indicator. In this case, please contact qualified service personnel or your local supplier.

MEDIANA
HEARTON
AED A16

Automated External Defibrillator





CPR FEEDBACK MODULE OPERATION

Operating the CPR Feedback Module

The CPR Feedback Module helps the user can perform CPR effectively.

Follow the steps below to use the CPR Feedback Module.

1. Attach the adhesive pad to the center of the patient's chest as shown in Figure 5.

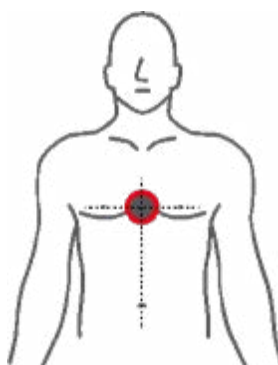

Figure 6. Place the Adhesive Pad

2. Attach the CPR Feedback Module that connected to the AED on the adhesive pad.
3. If the AED instructs CPR, place hands on the center of the CPR Feedback Module and press it according to beep sound.
4. Perform the CPR according to the voice prompt of the AED.

Note: For more information on performing CPR with voice prompts, see the **CPR OPERATION** section.

Note: If the feedback is not performed or the feedback from the CPR Feedback Module is not correct even though the CPR Feedback Module is connected to the AED, please contact the local distributor or Mediana service team immediately.

Note: If user has a CPR Feedback Module, it is recommended that user keep the CPR Feedback Module connected to the AED with the adhesive pad as preparation for emergency circumstances.

Note: The adhesive pads are disposable and must be discarded after use.



Replacing the CPR Feedback Module

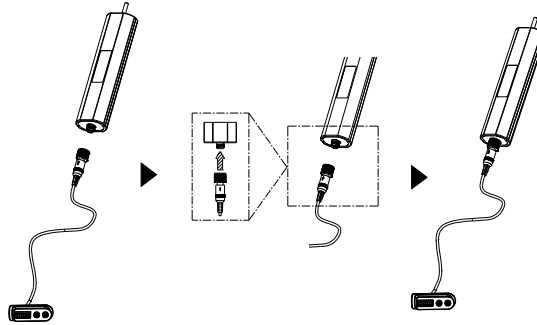

Figure 7. Replacing the CPR Feedback Module

1. Loosen the CPR Feedback Module connector and separate the pads and CPR Feedback Module.
2. Push the new CPR Feedback Module into the CPR Feedback Module connection socket of the pads fully inserted and tighten the connection.
3. Keep the adhesive pads with the AED as preparation for emergency circumstances.

Note: When the exchange of the pads, connect the CPR Feedback Module that connected to the pads which is needed exchange to the CPR Feedback Module connection socket of the new pads.

Note: The CPR Feedback Module is not disposable, so that if the pads is needed to exchange, connect the new pads and reuse.



USING THE AED

⚠ WARNING	The AED should not be used on someone who is responsive when shaken or breathing normally.
⚠ WARNING	Do not use the pads if the pad gel is dried or damaged.
⚠ WARNING	Disconnect non-defibrillation protected electronic devices or equipment from patient before defibrillation.
⚠ WARNING	Never lift the AED by the pads cable or any other accessory. Such accessories could detach, causing the AED to fall on the patient.
⚠ CAUTION	Prolonged or aggressive CPR to a patient with pads attached can damage the pads. Replace the pads if they are damage during use or handling.
⚠ CAUTION	Attach the adhesive pad to the patient's chest first and attach the CPR Feedback device onto the adhesive pad so that the CPR Feedback device can be secured to the patient's chest.
⚠ CAUTION	If the CPR Feedback Module is used, perform CPR according to the voice prompt from the AED.
⚠ CAUTION	Do not touch the patient and connector at the same time.

The AED is designed for the treatment of sudden cardiac arrest (SCA). It should only be used to treat someone who may be a victim of a SCA and is:

- Unresponsive,
- Non-breathing,
- Pulseless, (health care provider only)

If the person is unresponsive but you are unsure that they have suffered from a SCA begin CPR. When appropriate apply the AED and follow the voice prompts.

AHA/ERC guidelines (Rescue protocol)

The AED rescue protocol is consistent with the guidelines recommended by the **AHA/ERC 2015 Guidelines** for Resuscitation and Emergency Cardiac Care. The AED rescue protocol is subject to be upgradeable in order to be consistent with and optimized for the guidelines recommended by the **latest version of AHA/ERC Guidelines** for Resuscitation and Emergency Cardiac Care. Please contact your Mediana service representative for more information.

Note: AHA is the abbreviation for 'American Heart Association' and ERC is the abbreviation for 'European Resuscitation Council'.

Note: This section is described in accordance with ERC Guidelines. Differences for ERC Guidelines and AHA Guidelines are described with Note format.



Summary of CPR Guidelines

This “Guidelines Highlights” publication summarizes the AHA/ERC 2015 Guidelines. This is easy reference material for both lay rescuer and healthcare provider. Before installing the AED, it is recommended that the expected AED user should be trained to provide CPR and use the AED.

Note: The recommended procedure in below table is intended for the trained user. It is recommended that the untrained user calls the emergency service and follows the instruction directed by dispatcher.

Ensure scene safety.	Make sure you, the victim and any bystanders are safe.
Check the victim for a response.	Gently shake victim’s shoulders and ask loudly: “Are you all right?”
Open the airway, Check for breathing.	Open the airway. Look, listen and feel for normal breathing. Note: AHA 2015 Guidelines recommends that untrained user should call for help before checking for breathing and trained rescuers are encouraged to simultaneously perform ‘checking for pulse’ step.
After call for help, Send for AED.	Person not responsive? Not breathing normally? Ask a helper to call the emergency services if possible otherwise call them yourself. Stay with the victim when making the call if possible. Send someone to find and bring an AED if available. If you are on your own, do not leave the victim, start CPR. Note: AHA 2015 Guidelines indicates that helper gets AED if there is an AED nearby.
30 Compressions 2 Breaths UNTIL EMC ARRIVE.	Start chest compressions. After 30 compressions open the airway again and deliver two rescue breaths. Note: If untrained or unable to do rescue breaths, give chest compressions only CPR.
	Continue CPR until an AED is available or arrival of emergency physician.
	If the AED available, turn on and follow instructions.

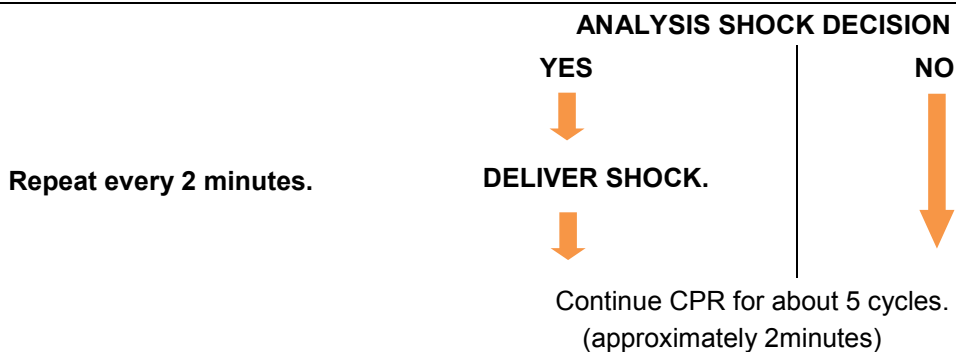



Pre Defibrillation Action

Prior to using the AED, it is advised to perform the following checks and actions in order to prepare the patient.

- Remove clothes to expose bare chest.
- If excessively hairy shave hair from areas to which defibrillation pads are to be applied.
- Ensure that the patient chest is dry. If necessary, dry chest area.

Operating the AED

⚠ WARNING	The Pediatric mode must be used on patients between 1 and 8 years or less than 25 kg (55lb).
⚠ WARNING	If the pads placement is inappropriate, the AED could harm the patient. To place the accurate position, must follow the voice prompt and action icon. When pads placement is inappropriate, treatment could not work, analysis could be incorrect, shock or no shock decision advisory could be inappropriate, or shock could burn the patient's skin.
⚠ WARNING	Do not place pads near the generator of an internal pacemaker. The analyzing heart rhythm of patient who is implanted pacemaker could inaccurate or the pacemaker might be damaged by defibrillator discharges.
⚠ WARNING	Do not perform chest compressions (CPR) through electrodes. These actions may damage the electrode pads cause the AED to function improperly.
⚠ WARNING	Always apply pads to flat areas of skin. Avoid application over folds of skin such as those underneath the breast or on obese patients. Excessive hair, poor adhesion, or air under pads may produce burns or ineffective energy transfer.
⚠ WARNING	To apply the pads to patient chest properly, shave hair from areas which defibrillation pads are to be applied if necessary.
⚠ WARNING	Always check the use by date on the pads and do not use the pads if the packaging has been previously opened. If the excessively dry pads are attached, AED may interpret as a condition that the pads are not attached to the patient.
⚠ WARNING	Touching the patient during the analysis phase of treatment can cause interference with the diagnostic process. Avoid contact with the patient while analysis is being carried out. The AED will instruct you by voice prompt when it is safe to touch the patient.
⚠ WARNING	The AED delivers shocks which can cause serious harm to operators and bystanders. Caution must be taken to ensure no-one is in contact with the patient when a shock is delivered.
⚠ WARNING	Make sure no one is touching the patient before you press the Shock button (in case of the Semi-Auto). Loudly announce, "Stand back! Do not touch the patient." And look down the entire length of the patient to ensure there is no contact with a bystander or conductive surface before pressing the Shock button.
⚠ WARNING	Make sure no one is touching the patient before the shock is automatically activated (in case of the Fully-Auto). "Shock will be delivered. Do not touch the patient. 3, 2, 1." When this voice is played, the electric shock is transmitted automatically, so look down the entire length of the patient to ensure there is no contact with a bystander or conductive surface.
⚠ WARNING	Do not touch the electrode surfaces, the patient, or any conductive



material touching the patient during ECG analysis or defibrillation.

Note: Only pads supplied by Mediana should be used. Using other types of pads may result in damage to the patient and the AED.

Note: When the voice prompt, “Replace pads.”, is played, ignoring the guidance and using the same pads can cause the fail of the deliver the energy that AED assured.

Note: If the AED is turned on in out-of-range of environmental operation condition described in this manual, temperature status will be blinked. In this case, place the AED in appropriate temperature before use it.

1. Check the status indicator displays “O”.
2. Remove the cover of the AED.
3. Turn on the AED by pushing the power button.
4. The AED automatically starts the Power-On-Self Test.
5. The test result is displayed on the status indicator and the voice prompt sounds.
 - Self test is passed : Voice prompt “Unit ok”, Status indicator “O”
 - Self test is failed : Voice prompt “Unit failed”, Status indicator “X”
6. If the pads are inserted already, Adult mode is default. Whenever pushing the patient mode switch button, user will hear the following voice prompt.
 - Adult icon’s LED lights up: “Adult mode”
 - Pediatric icon’s LED lights up: “Pediatric mode”



Figure 8. Patient mode switch Button

Note: The patient mode can switch even if any step except for CPR is going on progress. If the patient mode is changed, the AED will emit the voice prompt “Adult mode” or “Pediatric mode”. When the patient mode is changed during CPR, the AED will not emit the voice prompt.

Note: If the patient mode changes during Step 2 (ECG analysis) or Step 3 (delivering electric shock), notify the user that the electric shock has been canceled, and then repeat Step 2 (ECG analysis) again. However, if the electric shock is canceled more than 3 times before the completion of Step 3 (delivering electric shock), perform Step 4 (CPR).



If the pad is not inserted, you will hear the voice prompt:

- “Plug in pads. Insert connector firmly.”

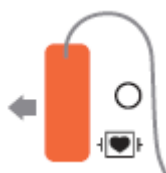

Figure 9. Pads disconnect icon (Chest type A16-DS, A16-DF)



Figure 10. Pads disconnect icon (Icon type A16-GS, A16-GF)

If the AED that is activated Pads Quality function and there is a problem with the pads, you will hear the voice prompt:

- “Replace pads.”

Note: If the pad connector is not connected in any step except for Step 4 (CPR), the AED will move to Pad connector disconnected icon and the voice prompt “Plug in pads. Insert connector firmly.” is emitted.

Note: If the pad is disconnected during Step 2 (ECG analysis) or Step 3 (delivering electric shock), notify the user that the electric shock has been canceled, and then the voice prompt “Plug in pads. Insert connector firmly.” is emitted. However, if the electric shock is canceled more than 3 times before the completion of Step 3 (delivering electric shock), perform Step 4 (CPR).

7. Verify the AED up to ‘6.’ which is activated normally and follow voice prompt and action icon. The red LED will flash near the relevant action icon.



Operation of HeartOn A16

Note: The AED with CPR First option turned on starts with step 4. The CPR First option can be set via service mode. It is applied to the chest type, A16-DS and A16-DF, only.

Step 1

Remove clothes to expose the patient's chest. If the patient has an excessively hairy chest, shave the area where the pads are about to be applied. Ensure that the patient chest is dry. If necessary, dry chest area.

- “Remove clothes from the patient’s chest. Place pad exactly as shown in the picture. Press pads firmly to patient’s bare chest.”

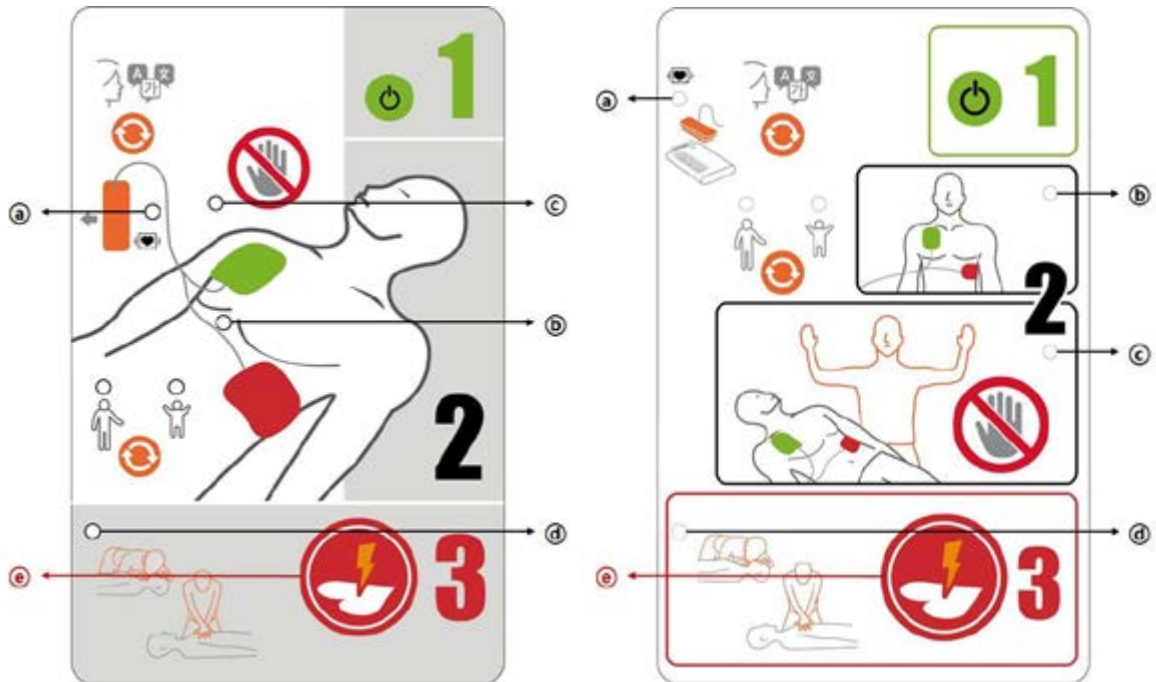
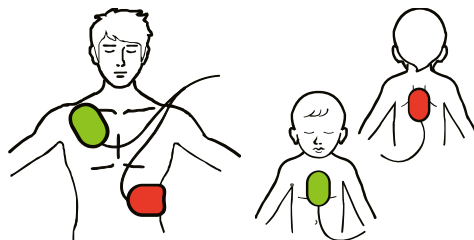

Figure 11. Action Icon – Step 1
(Left: Chest type·A16-DS, A16-DF(®), Right: Icon type·A16-GS, A16-GF(®))



Adult: age > 8, weigh ≥ 25kg(55lbs)
Pediatric: age ≤ 8, weigh < 25kg(55lbs)

Figure 12. Pads Placement



Step 2

When the pads are attached correctly to the patient you will hear the voice prompts:

- “Do not touch the patient.”
- “Analyzing and Charging”
- “Shock advised.”
- or
- “Do not touch the patient.”
- “Analyzing and Charging”
- “No shock advised.”

When the ECG rhythm is changed to a non-shockable rhythm after the voice prompt “Shock advised” is emitted or when the pads are disconnected, the following voice prompt will be emitted:

- “Shock cancelled.”

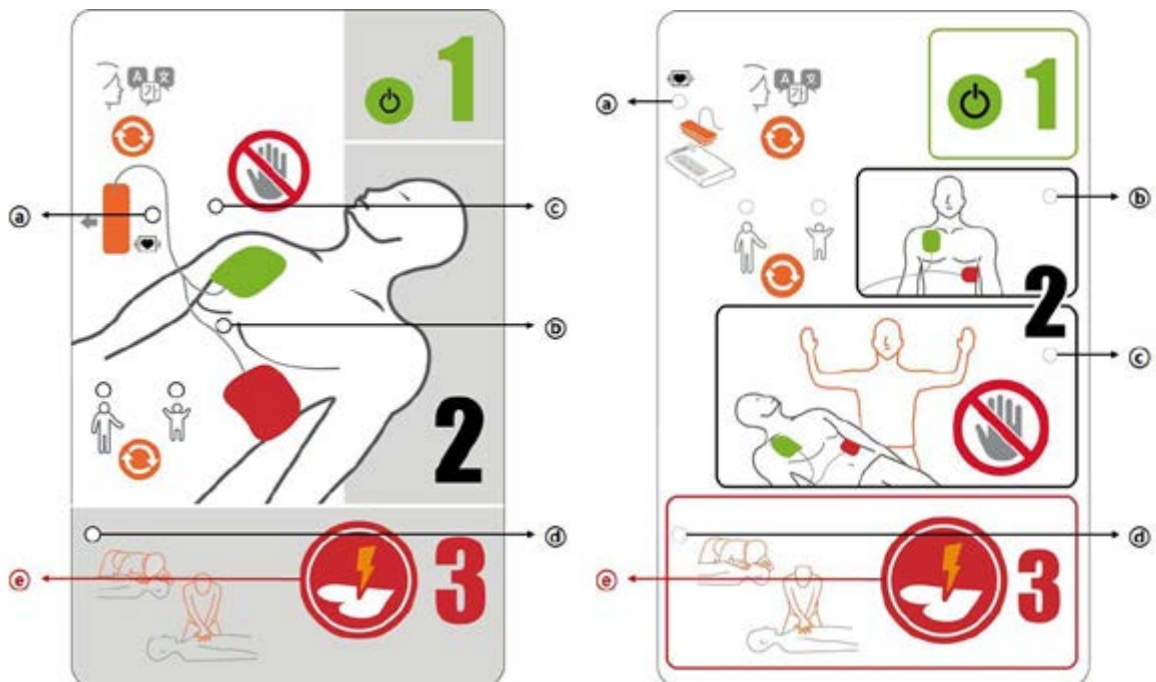

Figure 13. Action Icon – Step 2
(Left: Chest type·A16-DS, A16-DF(©), Right: Icon type·A16-GS, A16-GF (©))

Note: If “No shock advised”, the AED will move to Step 4 which demonstrate CPR process directly.

Note: The AED performs the Step 2 directly when it is turned on after the rescuer attaches the pads to the patient properly. Also, the Step 2 would be started if the pads are attached to the patient even if the AED is under the Step 1. This can reduce the preparing time for electric shock in case of trained rescuer.

Note: Follow voice prompt. Do not touch patient or allow any others to touch the patient while the AED is analyzing. After completion of analysis, the AED will advise you of treatment recommended. Care must be taken to keep the patient still. A moving patient can lead to incorrect, delayed or less effective diagnosis and therapy.

Note: If the shock cancel (when the pad connector is disconnected, the patient ECG, impedance, or mode is changed) has been occurred 3 times, the AED is performing the CPR process after the voice prompt “Shock cancelled” is emitted.



**Step 3
Semi-Auto**

- “Press the flashing button now.”
- “Shock delivered.”
- or
- “Press the flashing button now.”
- “Shock button not pressed.”

When the ECG rhythm is changed to a non-shockable rhythm before the shock button is pressed or when the pads are disconnected, the following voice prompt will be emitted:

- “Shock cancelled.”

Note: If the shock button is not pressed for 10 seconds after the voice prompt “Press the flashing button now.”, the same instruction will be emitted one more time. If the shock button is not pressed for more than 20 seconds after the initial instruction, the AED performs the CPR process after the voice prompt “Shock cancelled” is emitted.

Note: If the shock cancel (when the pad connector is disconnected, the patient ECG, impedance, or mode is changed) has been occurred 3 times, the AED is performing the CPR process after the voice prompt “Shock cancelled” is emitted.

Fully-Auto

- “Shock will be delivered.”
- “Do not touch the patient.”
- “Three, Two, One.”
- “Shock delivered.” or “Shock cancelled.”

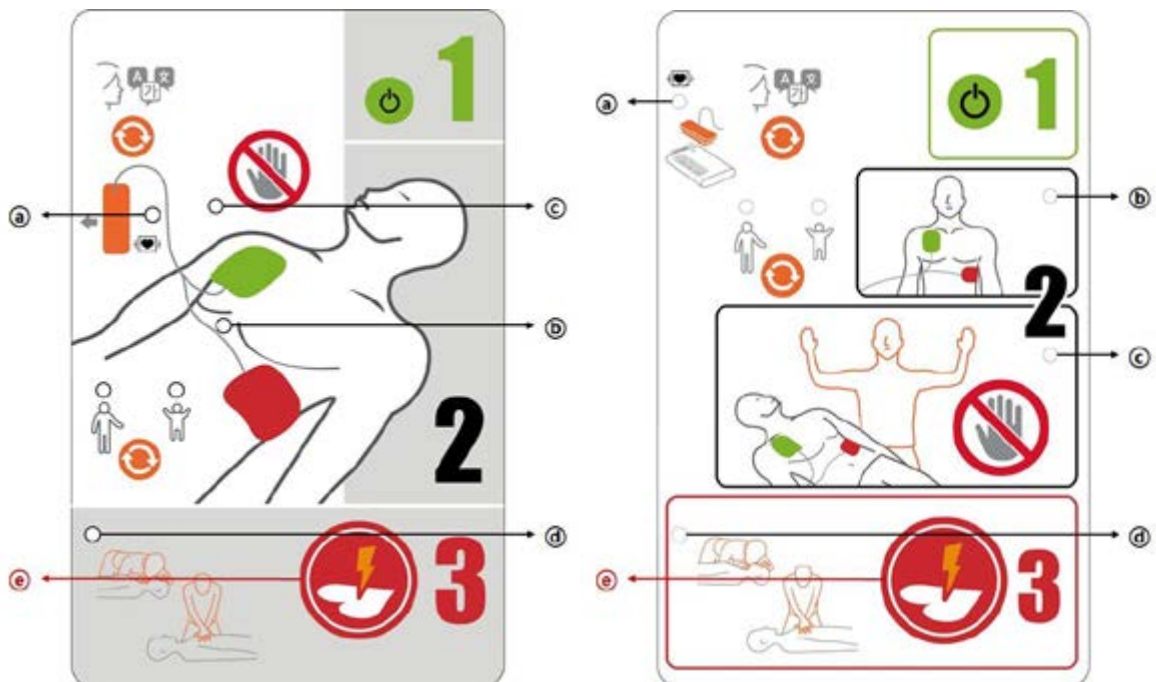

Figure 14. Action Icon – Step 3
(Left: Chest type·A16-DS, A16-DF (©,®), Right: Icon type·A16-GS, A16-GF(©,®))



Note: The AED will only administer a shock if it is needed. A voice prompt will tell you when to press the shock button to administer defibrillation therapy and when the electric shock will be delivered.

Note: If the shock cancel (when the pad connector is disconnected, the patient ECG, impedance, or mode is changed) has been occurred 3 times, the AED is performing the CPR process after the voice prompt “Shock cancelled” is emitted.

Step 4

When the electric shock is delivered, you will hear the voice prompts:

CPR Feedback option is disabled:

- “It is safe to touch the patient.”
- “Begin CPR.”

CPR Feedback option is enabled:

- “It is safe to touch the patient.”
- “Place CPR device in center of patient’s chest and begin CPR.”

When the electric shock is not delivered, you will hear the voice prompts:

CPR Feedback option is disabled:

- “It is safe to touch the patient.”
- “If needed begin CPR.”

CPR Feedback option is enabled:

- “It is safe to touch the patient.”
- “If needed, Place CPR device in center of patient’s chest and begin CPR.”

For more information on performing CPR, refer to **Perform CPR**.

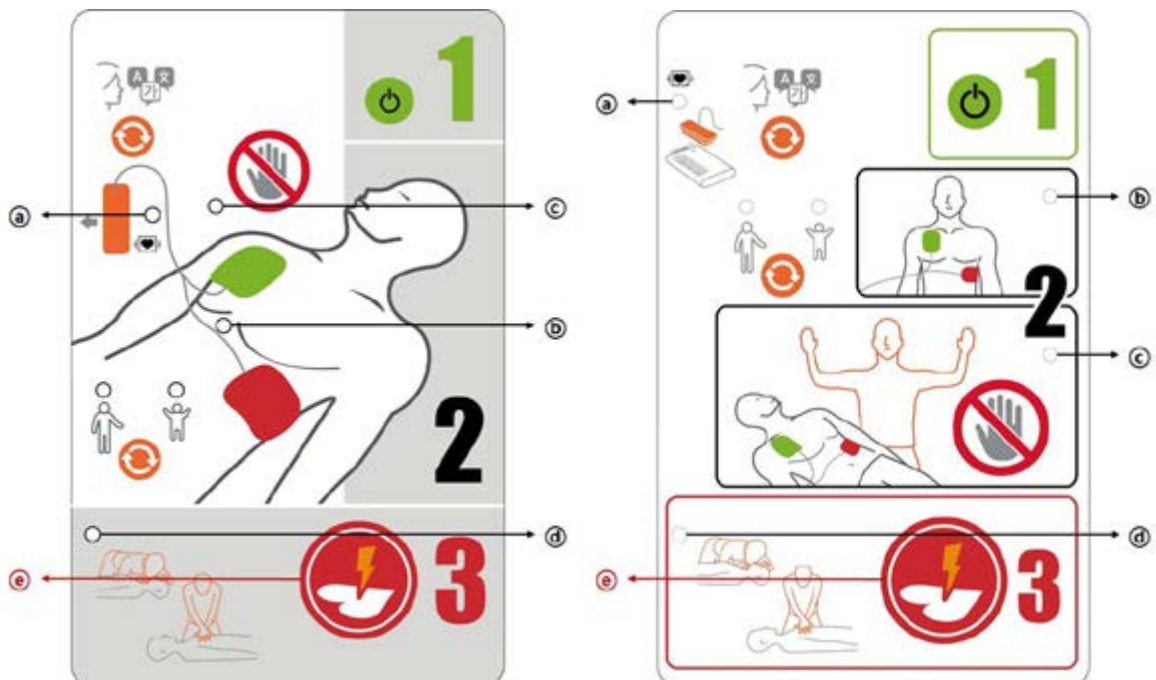

Figure 15. Action Icon – Step 4
(Left: Chest type-A16-DS, A16-DF(®), Right: Icon type-A16-GS, A16-GF(®))



Note: If the shock cancel (when the pad connector is disconnected, the patient ECG, impedance, or mode is changed) has been occurred 3 times, the AED is performing the CPR process after the voice prompt “Shock cancelled” is emitted.

Note: If the pad connector is not connected in any step except for Step 4 (CPR), the AED will move to Pad connector disconnected icon and the voice prompt “Plug in pads. Insert connector firmly.” is emitted.

Note: If the pad is disconnected during Step 4 (CPR), the AED move to the pads disconnected icon after completing the CPR and if the pad connector is connected to the AED, it moves to the Step 1.

Performing CPR

After the electric shock is delivered, you will hear the voice prompts:

- “It is safe to touch the patient.”

CPR Feedback option is disabled:

- “Begin CPR.”

CPR Feedback option is enabled:

- “Place CPR device in center of patient’s chest and begin CPR.”

Perform CPR according to the voice prompt of the AED.

In case of AED with CPR Feedback option, depending on the pressing speed and strength you will hear the voice prompts:

- “Press slower.”
CPR feedback: compression rate is too fast. Do chest compression in accordance with the beep sound.
- “Press faster.”
CPR feedback: compression rate is too slow. Do chest compression in accordance with the beep sound.
- “Press softer.”
CPR feedback: compression depth is too deep. Decrease the strength.
- “Press harder.”
CPR feedback: compression depth is too shallow. Increase the strength.

In case of AED with CPR Feedback option, depending on the pressing speed and strength you will hear the complex voice prompts:

- “Press slower and softer.”
CPR feedback: compression rate is too fast and compression depth is too deep. Do chest compression in accordance with the beep sound and decrease the strength.
- “Press slower and harder.”
CPR feedback: compression rate is too fast and compression depth is too shallow. Do chest compression in accordance with the beep sound and increase the strength.
- “Press faster and softer.”
CPR feedback: compression rate is too slow and compression depth is too deep. Do chest compression in accordance with the beep sound and decrease the strength.
- “Press faster and harder.”
CPR feedback: compression rate is too slow and compression depth is too shallow. Do chest compression in accordance with the beep sound and increase the strength.



In case of AED with CPR Feedback option, if the compression rate is not constant you will hear the voice prompts:

- “Press consistently.”
CPR feedback: compression rate is no consistency and compression depth is no consistency. Maintain the pressing speed and strength consistently.

In case of AED with CPR Feedback option, if the chest compression status is well you will hear the voice prompts:

- “Good compressions.”
CPR feedback: compression rate is good and compression depth is good. Keep the pressing speed and strength.

In case of AED with CPR Feedback option, if the user does not perform the CPR using CPR Feedback Module even though the AED instructs to perform the CPR, you will hear the voice prompts:

- “Place CPR device in center of patient’s chest and begin CPR.”

When performing CPR, use the beep sound from the AED for compression rate – the AED emits a tone at a rate of 100, 105, 110, 115, or 120 beats per minute depending on the setting.

The AED instructs CPR depending on the setting.

- Perform 2, 3, 4, 5, 6, 7, 8, 9, or 10 cycles of CPR, each cycle include 15 or 30 times of chest compression and 1 or 2 times of rescue breaths.
- Perform the chest compression without rescue breath for 30, 60, 90, 120, 150, or 180 seconds.

The number of compression, compression rate, compression speed, and the number of rescue breaths can be set via service mode.

After you hear the following voice prompt, the AED will then return to ECG analyzing procedure. Continue to follow this instruction until emergency physician arrives and then hand over patient to emergency physician.

- “Stop CPR.”
- “Adult mode” or “pediatric mode”



Note: In accordance with AHA/ERC 2015 Guidelines,

- the recommended compression rate is 100 ~ 120 beats per minute,
- the recommended compression depth is at least 2 inches (5 cm), but not more than 2.4 inches (6 cm),
- the recommended compression ventilation ratio is 30:2,
- the recommended duration is 5 cycles (30:2 x 5 cycles).

Note: Your Mediana dealer will have trained you in the particular SCA treatment protocol you have chosen. In all cases follow the voice prompts and visual instructions given by the AED.



Note User and Bystander Safety

 WARNING	Make sure no one is touching the patient before you press the Shock button (in case of the Semi-Auto). Loudly announce, “Stand back! Do not touch the patient.” And look down the entire length of the patient to ensure there is no contact before pressing the Shock button.
 WARNING	Make sure no one is touching the patient before the shock is automatically activated (in case of the Fully-Auto). “Shock will be delivered. Do not touch the patient. 3, 2, 1.” When this voice is played, the electric shock is transmitted automatically, so look down the entire length of the patient to ensure there is no contact.

Do not touch the patient while the AED is analyzing or delivering a shock is in process. Defibrillation energy can cause injury. As long as the AED is used according to the directions, and no one is in contact with the patient when the **Shock button** is pressed, there is no risk of harm to the rescuer or bystanders. The AED cannot deliver a shock unless the pads are applied to someone whose heart is in need of a shock.

Note: See warnings and cautions for more details.



MAINTENANCE

⚠ WARNING	Improper maintenance which is provided in this manual may damage the AED or cause it to function improperly. Maintain the AED according to directions.
⚠ WARNING	Do not let fluids to get into the AED. Avoid spilling any fluids on the AED or its accessories. Spilling fluids into the AED may damage it or cause a fire or electric shock hazard. Do not sterilize the AED or its accessories.
⚠ WARNING	Do not immerse any part of the AED in water or any type of fluid. Contact with fluids may seriously damage the AED or cause fire or electric shock hazard.
⚠ WARNING	Do not attempt to warm the pads with a heat source greater than 43°C (109.4°F).
⚠ WARNING	Do not immerse or clean the pads with alcohol or bleach.
⚠ WARNING	Do not clean the AED with abrasive materials, cleaners or solvents.
⚠ CAUTION	Follow local government ordinances and recycling instructions regarding disposal or recycling of AED components, including batteries.
⚠ CAUTION	Do not short-circuit the battery, as it may generate heat. To avoid short-circuiting, do not let the battery terminal come in contact with metal objects at any time, especially when transporting.
⚠ CAUTION	Do not solder the battery directly. Heat applied during soldering may damage the safety vent in the battery's positive cover.
⚠ CAUTION	Do not deform the battery by applying pressure. Do not throw, hit, drop, fold or impact the battery.
⚠ CAUTION	Do not use the battery with other maker's batteries, different types or models of batteries such as dry batteries, nickel-metal hydride batteries, or Li-ion batteries together, as they might leak electrolyte heat or explode.
⚠ CAUTION	Do not mistreat the battery, or use the battery in applications not recommended by Mediana.
⚠ CAUTION	Keep the battery out of reach of babies and children to avoid any accidents.
⚠ CAUTION	If there are any problems with the battery, immediately put the battery in a safe place and contact qualified service personnel or your local supplier.
⚠ CAUTION	Replacing new battery and placing the pads should carry out in environmental conditions described in this manual. If the AED is operated in out-of-range for environmental conditions, the AED can't be operated properly.

After using the AED, Mediana technical support recommend you perform the following actions:

1. Use the HeartOn AED Event Review Software to download information about the therapy performed and store appropriately. (If you do not have the HeartOn AED Event Review Software, please contact your dealer who can arrange for the incident to be downloaded)
2. Remove the used the pads from your AED and dispose of in a suitable manner. (For recommended disposal methods please refer to section the recycling and disposal)
3. Check the exterior of the AED for cracks or other signs of damage. Contact your distributor or Mediana technical support immediately if any damage is found.
4. Check the exterior of the AED for dirt or contamination. If necessary, clean the AED with approved cleaning products.



5. Check supplies, accessories and spares for damage or expiration. Replace immediately if any damage or expiration is found. Contact your local Mediana approved dealer.
6. Install the new pads or battery. Before installing the new pads check that its use by date has not been exceeded.
7. After installation of the new battery. Check the status Indicator. If the status Indicator is not displaying “O” refer to the troubleshooting section of this manual. If the problem persists, contact Mediana or your local approved dealer for technical support.
8. Turn on the AED and verify that the AED operates in the correct manner i.e. voice prompt “Unit OK” can be heard. Turn off the AED by pressing the power button.
9. Contacting Mediana after use. At Mediana we like to hear from our customers whenever they have any occasion to use any of our products, even if therapy is not delivered as part of the incident. This information is vital to the continued development and constant improvement we strive for in the treatment of sudden.

Recycling and Disposal

When the AED, battery or accessories reach the end of useful life, recycle or dispose of the equipment according to appropriate local and regional regulations.

Note: The AED should be disposed of separately from the municipal waste stream via designated collection facilities appointed by the government or the local authorities.

Note: The correct disposal of your old appliance will help prevent potential negative consequences for the environment and human health.

Note: For more detailed information about disposal of your old appliance, please contact your city office, waste disposal service or the shop where you purchased the AED.

Note: Please delete the relevant information to prevent leakage of personal information before the disposal the AED.

Returning the AED and System Components

To return the AED and/or accessories, contact qualified service personnel or your local supplier.

Service

The AED requires no routine service other than cleaning, battery maintenance, and service activity which is mandated by the user’s institution. For more information, refer to the AED service manual. Qualified service personnel in the user’s institution should perform periodic inspections of the AED. If service is necessary, contact qualified service personnel or your local supplier.

Periodic Safety Checks

It is recommended that the following checks be performed every month.

- Inspect the equipment for mechanical and functional damage.
- Inspect the external safety labels for legibility.



Cleaning

To clean the AED, wipe the AED with a soft cloth that has been dampened by one of the following:

- Quaternary Ammonium (fungicidal, bactericidal and virucidal against enveloped viruses)
- Isopropyl alcohol (70% solution).
- 10% Chlorine bleach solution

For pads, follow cleaning instructions in the directions for use shipped with those components.

Avoid spilling liquid on the AED, especially in connector areas. If liquid is accidentally spilled on the AED, clean and dry thoroughly before reuse. If in doubt about AED safety, refer the unit to qualified service personnel or your local supplier for checking.

Battery Maintenance

The new battery lifetime in use can be more than 6 hours monitoring or 200 shocks (excepting the CPR period between the defibrillation therapy) or a combination of both. The battery in the standby mode (inserted into the AED) has standby life (5 years from manufacture date). If the battery status is flashing with one bar, you may need to replace the battery with a fresh battery. If the battery is not inserted into the AED, the battery has a shelf life. (2 years from manufacture date)

For diagnosis of the reason for status indicator display “X”, please refer to the troubleshooting section.

Replacing the Battery

Please refer to the Figure 3 and Figure 4.

Pads Maintenance



Figure 16. Pads status icon

Pads status displays the following description.

- If the pads are disconnected with the AED, the pads status will be displayed.
- For the AED with the pads quality feature, the pads status will be displayed if there is a problem with the pad connected to the AED. (expiration of the pads, expired pads, damaged pads or recommended replacement of the pads)



Replacement of the pads must be carried out if:

- The use by date of the pads has been exceeded.
- When the pads have been used. (It is a single use item and must be replaced with new pads.)
- The package of new pads has been previously damaged.
- The pads have been vent.
- “Replace Pads.” voice Prompt is played.
- Pads Status icon is displayed even though the pads are connected.

Replacing Pads

1. Take the replacement pads from its protective bag.
2. Disconnect the pad connect from the AED.
3. Push the pads firmly to ensure it is fully inserted.
4. Turn on the AED.
5. Check the status indicator. If the pads have been inserted correctly, the status Indicator displays “O” and the voice prompt “Unit ok.” is emitted.
6. If the status indicator displays “X” or the voice prompt, “Unit fail.” is emitted, inform relevant safety officer or person responsible for maintenance of the AED.
7. Update the relevant information to show the date that the replacement of pads and battery was placed into service.
8. Dispose of the old pads.

CPR Feedback Module Maintenance

Replacement of the CPR Feedback Module must be carried out if:

- CPR Feedback is not performed despite the CPR Feedback Module connected to the AED.
- CPR Feedback from the CPR Feedback Module is abnormal.

Replacing CPR Feedback Module

Please refer to the Figure 7.



The AED Maintenance

Mediana recommends users perform regular maintenance checks. A suggested maintenance check would be.

1. Check the status Indicator. If the status Indicator displays “X”, a problem has been detected. Refer to the troubleshooting section of this manual.
2. Check the use by date of the pads. If the pads have exceeded its use by date , remove it and replace with the pads. Contact qualified service personnel or your local supplier for replacements.



Figure 17. Use by date of Pads

3. Check the AED and accessories for damage or use by date. Replace any accessories found to be damaged or that have exceeded their use by date.
4. Check the exterior of the AED for cracks or other signs of damage. Contact qualified service personnel or your local supplier if any damage is found.
5. Check that trained user is aware of the AED location and that it is easily accessible for those Responders at all times.
6. Ensure all trained user have up to date training for both CPR and AED use. For recommended retraining intervals please consult the organization or body used to provide the Training.

MEDIANA
HEARTON
AED A16

Automated External Defibrillator





TROUBLESHOOTING

⚠ WARNING	If you are uncertain about the accuracy of any measurement, check the patient’s vital signs by alternate means; then make sure the AED is functioning correctly.
⚠ WARNING	To reduce the risk of electrical shock, do not attempt to remove the cover under any circumstances. There are no operator serviceable components and only a qualified technician should service the AED.
⚠ WARNING	Please contact qualified service personnel or your local supplier if unintentional equipment changes or attacks from outside is found.

General

If the AED detects an error, it can display the “X” on the status indicator. Contact qualified service personnel or your local supplier. Before calling to qualified service personnel or your local supplier, make sure it meets environmental conditions provided in the manual as temperature, humidity, altitude and so on.

Corrective Action

Check used by date the pads. Change the pads if use by date has been exceeded. Check shelf life or standby life of the battery. Change the battery if the shelf life or standby life has been exceeded.

Following is a list of possible errors and suggestions for corrective action.

If the status indicator is still not displaying “X” or a warning message is heard when the AED is turned on or if for any reason, you have suspicions that your AED is not working correctly contact qualified service personnel or your local supplier or Mediana directly for support. (info@mediana.co.kr)

- 1. There is no response to the pushing the power button of the AED.**
 - A main board may be malfunctioned. Notify qualified service personnel or your local supplier to check and replace the main board.
 - The battery may be missing or discharged. If the battery is missing, insert the battery (See Battery Operation section). If the battery is discharged, change the battery. (See Maintenance section)
- 2. The beep tones do not sound during the operation.**
 - Do not use the AED; contact qualified service personnel or your local supplier.
- 3. The beep tones sound but voice does not function properly.**
 - Do not use the AED; contact qualified service personnel or your local supplier.
- 4. The voice prompt “Plug in pads. Insert connector firmly”.**
 - Reconnect the pad connector with pad socket firmly or replace the pad.
- 5. The action icon does not flash.**
 - Do not use the AED, contact qualified service personnel or your local supplier.
- 6. The voice prompt is unclearly heard.**
 - Do not use the AED, contact qualified service personnel or your local supplier.
- 7. The battery status does not indicate 3 bar despite of replacing new battery.**
 - If the battery status still not displayed 3 bar despite of replacing new battery, do not use the AED and contact qualified service personnel or your local supplier.
- 8. The pads status icon is displayed despite of replacing new pads.**
 - If the pads status icon is displayed despite of replacing new pads, do not use the AED and contact qualified service personnel or your local supplier.



EMI (Electromagnetic Interference)

⚠ WARNING	Keep patients under close surveillance during delivering a shock. It is possible, although unlikely, that radiated electromagnetic signals from sources external to the patient and the AED can cause inaccurate measurement readings. Do not rely entirely on the AED readings for patient assessment.
⚠ WARNING	It is possible that any radio frequency transmitting equipment and other nearby sources of electrical noise may result in disruption in the AED operation.
⚠ WARNING	It is possible, although unlikely, that large equipment using a switching relay for its power on/off may affect the AED operation. Do not operate the AED in conjunction with electrocautery or diathermy equipment or in such environments.

This AED has been tested and found to comply with the limits for Medical devices to the IEC60601-1-2, and the Medical device Directive 93/42/EEC. These limits are designed to provide reasonable protection against harmful interference in a typical medical installation.

However, because of the proliferation of radio-frequency transmitting equipment and other sources of electrical noise in health care environments (such as electrosurgical equipment, cellular phones, mobile two-way radios, electrical appliances, and high-definition television), it is possible that high levels of such interference due to close proximity or strength of a source may affect AED operation.

⚠ WARNING	The AED is designed for use in environments in which the signal can be obscured by electromagnetic interference. During such interference, measurements may seem inappropriate or the AED may not seem to operate correctly.
------------------	---

The AED disruption may be indicated by erratic readings, cessation of operation, or other incorrect functioning. If this occurs, survey the site to determine the source of this disruption. Try the following actions to see if they eliminate the disruption:

- Turn equipment in the vicinity off and on to isolate the offending equipment.
- Reorient or relocate the interfering equipment.
- Increase the separation between the interfering equipment and this equipment.

The AED generates, uses, and can radiate radio frequency energy. If the AED is not installed and used in accordance with these instructions, the AED may cause harmful interference with other devices in the vicinity.

If assistance is required, contact qualified service personnel or your local supplier.

Obtaining Technical Assistance

For technical information and assistance, or to order the AED service manual, call your local supplier. The service manual provides information required by qualified service personnel or your local supplier when servicing the AED.



GLOSSARY

Sudden Cardiac Arrest (SCA)

Sudden cardiac arrest is a condition in which the heart suddenly stops pumping effectively due to a malfunction of the heart's electrical system. Often victims of SCA have no prior warning signs or symptoms. SCA can also occur in people with previously diagnosed heart conditions. Survival for an SCA victim depends on immediate cardio-pulmonary resuscitation (CPR). The use of an external defibrillator within the first few minutes of collapse can greatly improve the patients' chances of survival. Heart attack and SCA are not the same, though sometimes a heart attack can lead to a SCA. If you are experiencing symptoms of a heart attack (pain, pressure, shortness of breath, squeezing feeling in chest or elsewhere in the body) seek emergency medical attention immediately.

Heart Rhythm

The normal electrical rhythm by which the heart muscle contracts to create blood flow around the body is known as Sinus Rhythm. Ventricular Fibrillation (VF) caused by chaotic electrical signals in the heart is often the cause of SCA, but a shock can be administered to re-establish sinus rhythm. This treatment is called defibrillation. The AED is designed to automatically detect ventricular fibrillation (VF) and perform defibrillation on victims of sudden cardiac arrest.

Detecting Fibrillation

The electrical rhythm by which the heart muscle contracts can be detected and used for medical diagnosis and the resulting reading is called an Electrocardiogram (ECG). The AED has been designed to analyze a patient's ECG in order to detect ventricular fibrillation (VF) in the heart. If ventricular fibrillation (VF) is detected the AED will deliver a carefully engineered electrical shock designed to stop the chaotic electrical activity experienced within the heart muscle during SCA. This may allow the victim's heart to return to a sinus rhythm.

Ventricular Tachycardia / Ventricular Fibrillation

Is a life-threatening heart rhythm that is treatable with the therapy using the AED.

Sinus Rhythm

Sinus Rhythm is the normal electrical rhythm by which the heart muscle contracts and expands to create blood flow around the body.

Biphasic Shock

A biphasic shock is an electrical current that is passed through the heart, firstly in one direction and then in another.

Biphasic Truncated Exponential (BTE) waveform

Biphasic Truncated Exponential (BTE) waveform stands for Self-Compensating Output Pulse Envelope Waveform.

Pads

Pads are the electrodes that are connected to the patient's chest in order to administer therapy.



Electromagnetic Interference

Electromagnetic interference is radio interference that may cause erroneous operation of electronic equipment.

Impedance Measurement

Impedance measurement is a check that is performed to check the integrity of AED patient contact.

HeartOn A16

The AED is a semi-automatic/fully-automatic device used for the delivery of external defibrillation therapy to resuscitate victims of SCA, who are unresponsive, are not breathing, or without life signs.

HeartOn AED Event Review Software

HeartOn AED Event Review Software is software that can be used in conjunction with the AED and SD card (or Infrared communication cable). It can retrieve and view information about therapy delivered using the AED. Also, HeartOn AED Event Review Software can be used to configure the AED.

CPR Feedback Module

User can perform CPR more accurately by feedback on the CPR performed to the patient.

Adhesive Pad

The Adhesive Pad prevents the CPR Feedback Module from falling out for patient for using the AED smoothly.

More Information

If you have had any occasion to use your AED or if you require any further information on the AED, its accessories or any other products please contact us.



SPECIFICATION

Defibrillation Electric Shock

Waveform	Biphasic Truncated Exponential (BTE) waveform (impedance compensation)
Energy	Adult: 170 to 195J (±5%) Pediatric: 44 to 51J (±5%)
Operating mode	Semi-Auto, Fully-Auto

ECG

Lead	II (RA, LL)
Patient impedance	25 to 200 ohm
Heart Rate	20 to 350 per min
Accuracy	1 per min
Detection	V/F greater than or equal to 0.2 mV V/T Adult: greater than or equal to 150 bpm Pediatric: greater than or equal to 180bpm
Lead connection	Confirm the connection and emit voice prompt
Filter	0.5 to 30 Hz

Indication

Controls	
Standard	Power button, Shock button, Patient mode switch button, Select language button
Indicators	
Visible	Action icon, Status LCD(AED status, Battery status, Temperature status, PADS status), LED
Audible	Audio speaker (Voice prompt, CPR indication) Beep (CPR indication, Power on, Critically Low Battery, Self-Test fail, alarm of abnormal operation)

Physical

Dimensions	200 × 286.5 × 90 (mm) (W×H×D)
Weight	Approx. 1.95 kg including the battery
Degree of Protection against Electric Shock	Pads: Type CF with defibrillator protection



Environmental Conditions

Operation/Standby	
Temperature	0 to 43°C (32 to 109.4°F)
Relative Humidity	5 to 95% RH (Non-condensing)
Altitude	0 to 4,575 m
Shock	Acceleration: 100 G (+/- 10%) Time: 6 msec The number of shocks: 3 times/axis (6 axes (+/- X, Y, Z))
Vibration	Frequency: 10Hz to 2000Hz Acceleration : 10 Hz to 100 Hz: 5,0 (m/s ²)/Hz 100 Hz to 200 Hz: -7 dB per octave 200 Hz to 2000 Hz: 1,0 (m/s ²)/Hz
Drop height	0.75m
Water and dust resistance	IP55 (IEC60529)
Note: The Standby condition indicates that the self test periodically runs with installed battery in the AED.	
Storage (in shipping container)	
Temperature	-20 to 60°C (-4 to 140°F)
Relative Humidity	5 to 95% RH (Non-condensing)
Altitude	0 to 12,192 m

Self Test

Self Test	
Temperature	0 to 43°C (32 to 109.4°F)
Cycle	Every 24 hours, 1 week, 1 month Power on self test, Battery insertion self test
Test result	Status LCD displays "O"/ "X".
Note: Only when the battery is installed, self test will be activated.	

Data Backup and Communication

Standard	SD card(Optional), Infrared communication port
----------	--

Expected Service Life

Expected service life	10 years
-----------------------	----------



Accessories Specifications

Pads

Adult / Pediatric Pads	
Shelf life	Refer to pad's direction for use
Electrodes	Disposable pads
Placement	Adult: Anterior-lateral Pediatric: Anterior-posterior
Minimum active gel area	80 cm ² +/-5%
Cable length	About 1.8 m
Environmental Conditions	
Temperature	Operation: 0 to 43°C (32 to 109.4°F)
	Storage: 0 to 43°C (32 to 109.4°F)
Relative Humidity	5 to 95% RH (Non-condensing)

Battery

Battery	
Type	LiMnO ₂ , Disposable, Long-Life Primary Cell
Voltage/Capacity	15V, 3000 mAh
Shelf Life (in the original packaging)	2 years from manufacture date
Standby Life (inserted in the AED)	5 years from manufacture date
Discharge	A minimum of 200 shocks (excepting the CPR period between the defibrillation therapy) or more than 6 hours of operating time at 20°C
Environmental Conditions	
Temperature	Operation: 0 to 43°C (32 to 109.4°F)
	Storage: 10 to 25°C (50 to 77°F)
Relative Humidity	5 to 95% RH (Non-condensing)



CPR Feedback Module

CPR Feedback Module (option)	
Dimensions	80 mm diameter
Medical device class	IM
Environmental Conditions	
Temperature	Operation: -5 ~ 50°C (23 ~ 122°F) Storage: -30 ~ 70°C (-22 ~ 158°F)
Relative Humidity	15% RH ~ 95% RH
Parameters	
Durability (Compression)	app. 500'000 cycles
Measuring range	
Frequency	1 to 160 compression /min
Depth	1 to 127 mm
Accuracy (flat surface)	
Frequency	+/- 3 /min (averaged)
Depth	< 10%
Ingress Protection	IP55
Impact Protection	IK09

Adhesive Pad

Adhesive Pad (option)	
Dimensions	100 mm diameter

Defibrillation waveform

Defibrillation waveform

Waveform parameters

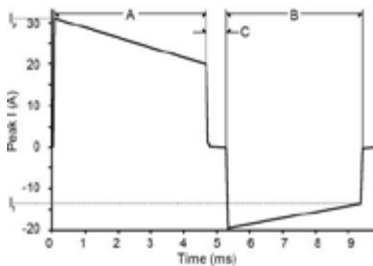

Waveform parameters are automatically adjusted as a function of patient defibrillation impedance. In the diagram at left, A is the width of pulse 1 and B is the width of pulse 2 of the waveform, C is the inter-pulse delay, I_p is the peak current, and I_f the final current.

The AED delivers shocks to load impedances from 25 to 200 ohm. The duration of each pulse of the waveform is dynamically adjusted based on delivered charge, in order to compensate for patient impedance variations, as shown below:

Adult defibrillation			
Load Resistance (Ω)	Pulse width 1 (ms)	Pulse width 2 (ms)	Delivered Energy (J)
25	3.3	3.1	195
50	4.7	4.1	190
75	6.7	4.7	185
100	8.3	5.9	195
125	9.7	6.7	190
150	11.3	7.9	185
175	11.7	8.7	180
200	11.7	8.7	170



Pediatric defibrillation			
Load Resistance (Ω)	Pulse width 1 (ms)	Pulse width 2 (ms)	Delivered Energy (J)
25	3.3	3.1	51
50	4.7	4.1	50
75	6.7	4.7	49
100	8.3	5.9	51
125	9.7	6.7	50
150	11.3	7.9	49
175	11.7	8.7	47
200	11.7	8.7	44

Charging Time	< 10 seconds typical (with new battery)
After 6 discharges, the maximum time from the initiation of rhythm analysis with a clear ECG signal to readiness for discharge	Approx. 12 seconds
After 6 discharges, initially switching power on to ready for discharge at maximum energy	Approx. 21 seconds
Shock Analysis Time	< 8 seconds typical Note: Shock analysis would take about 16 seconds at maximum from the start to the completion of analysis if ECG signal is interfered by motion or others.
Disarm	The AED constantly detects ECG signals from after the ECG analysis to before delivering the shock. If the ECG rhythm changed to a nonshockable rhythm, the shock energy that is accumulated on the high-voltage capacitor will be disarmed through internal resistance. If the shock button is not pressed during 20 seconds, the shock energy that is accumulated on the high-voltage capacitor will be disarmed through internal resistance.



ECG Analysis Performance

Rhythm class	AHA-DB	MIT-DB	CU-DB	VF-DB	VT-DB	Total number of sample size
VF-shockable : TP	988	22	282	908	-	2200
VF-shockable : FN	44	0	7	23	-	74
VF-shockable : sensitivity(%)	95.74	100.00	97.58	97.53	-	96.75
Adult mode	-	-	-	701	-	701
VT-shockable : TP	-	-	-	66	-	66
Adult mode	-	-	-	91.40	-	91.40
VT-shockable : FN	-	-	-	-	-	-
Adult mode	-	-	-	-	18	18
VT-shockable : TP	-	-	-	-	3	3
Pediatric mode	-	-	-	-	81.82	81.82
VT-shockable : FN	-	-	-	-	-	-
Pediatric mode	-	-	-	-	-	-
VT-shockable : sensitivity(%)	-	-	-	-	-	-
Non-shockable : TN	32291	17518	1267	7062	-	58138
Non-shockable : FP	0	2	8	33	-	43
Specificity(%)	100.00	99.99	99.37	99.53	-	99.93
Positive Predictive Value	100.00	91.67	97.24	97.99	100.00	98.55

Database for ECG Analysis

- From AHA (American Heart Association) official database
- From MIT (Massachusetts institute Technology) official database
(CU-DB: The Creighton University Sustained Ventricular Arrhythmia Database,
VF-DB, VT-DB: MIT-BIH Malignant Ventricular Arrhythmia Database)

ECG rhythm to determine if a shock is appropriate

- Ventricular Fibrillation at a amplitude greater than or equal to 0.2mV.
- Ventricular Tachycardia at a heart rate greater than or equal to 150 bpm (Adult) / 180 bpm (Pediatric).



Compliance

Item	Standard	Description
Classification	IEC 60601-1:2005+A1:2012 EN 60601-1:2006 A1:2013	Internally powered (on battery power)
Type of protection	IEC 60601-1:2005+A1:2012 EN 60601-1:2006 A1:2013	Type CF – Applied part
Mode of operation	IEC 60601-1:2005+A1:2012 EN 60601-1:2006 A1:2013	Continuous
Degree of protection	IEC 60529:1989+A1:1999 +A2:2013 EN 60529:1991+A1:2000 +A2:2013	IP55 (provided by enclosures)
General	ISO 13485:2003/Cor 1:2009 EN ISO 13485:2012/AC:2012	Quality systems - Medical devices - Requirements for regulating purposes
	ISO 14971:2007 EN ISO 14971:2012	Application of risk management to Medical devices
	IEC 62304:2006+A1:2015 EN 62304:2006/AC:2008	Medical device software - Software life-cycle processes
	IEC 60601-1-6:2010 +A1:2013 EN 60601-1-6:2010	Medical electrical equipment - Part 1-6: General requirements for basic safety and essential performance - Collateral standard: Usability
	IEC 62366-1:2015 EN 62366-1:2015	Medical devices - Application of usability engineering to Medical devices
	IEC60601-1-11:2015	Medical electrical equipment - Part 1-11: General requirements for basic safety and essential performance - Collateral Standard: Requirements for medical electrical equipment and medical electrical systems used in the home healthcare environment
	Ambulance	EN 1789:2007 +A2:2014
Defibrillator	IEC 60601-2-4:2010 EN 60601-2-4:2011	Medical electrical equipment - Part 2-4: Particular requirements for the basic safety and essential performance of cardiac defibrillators
EMC	IEC 60601-1-2:2014 EN 60601-1-2:2015	Electromagnetic compatibility-requirements & test
Package	ISTA (Procedure 2A, 2001)	Pre-Shipment test procedures (Package)
Battery	IEC 60086-4:2014	Primary batteries – Part 4: Safety of lithium batteries



Manufacturer's Declaration

⚠ WARNING	For best product performance and measurement accuracy, use only accessories supplied or recommended by Mediana. Use accessories according to the manufacturer's directions for use and your facility's standards. The use of accessories, transducers, and cables other than those specified may result in increased emission and/or decreased immunity of the AED.
⚠ WARNING	Portable RF communications equipment (including peripherals such as antenna cables and external antennas) should be used no closer than 30 cm (12 inches) to any part of the AED, including cables specified by the manufacturer. Otherwise, degradation of the performance of this equipment could result.

The AED is suitable for use in the specified electromagnetic environment. The customer and/or user of the AED should assure that it is used in an electromagnetic environment as described below;

Table 5. Electromagnetic Emissions (IEC60601-1-2)

Emission Test	Compliance	Electromagnetic Environment
RF emission CISPR 11	Group 1	The AED must emit electromagnetic energy in order to perform its intended function. Nearby electronic equipment may be affected.
RF emissions CISPR 11	Class B	The AED is suitable for use in all establishments.

Table 6. Electromagnetic Immunity (IEC60601-1-2)

Immunity Test	IEC60601-1-2 Test Level	Compliance Level	Electromagnetic Environment Guidance
Electrostatic discharge (ESD) IEC 61000-4-2	±8 kV contact ±15 kV air	±8 kV contact ±15 kV air	Floor should be wood, concrete, or ceramic tile. If floors are covered with synthetic material, the relative humidity should be at least 30 %.
Power frequency (50 Hz) magnetic field IEC 61000-4-8	30 A/m	30 A/m	It may be necessary to position the AED further from the sources of power frequency magnetic fields or to install magnetic shielding. The power frequency magnetic field should be measured in the intended installation location to assure that it is sufficiently low.
Note: UT is the AC mains voltage prior to application of the test level.			



Table 8. Recommended Separation Distances

Recommended separation distance between Portable and mobile RF communications equipment and the AED		
<p>The AED is intended for use in an electromagnetic environment in which radiated RF disturbances are controlled. The customer or the user of the AED can help prevent electromagnetic interference by maintaining a minimum distance between portable and mobile RF communications equipment (transmitters) and the AED as recommended below, according to the maximum output power of the communications equipment.</p>		
Rated Maximum Output Power of Transmitter in watt	Separation distance according to frequency of transmitter in meter	
	80 MHz to 800 MHz $d = 1.2 \sqrt{P}$	800 MHz to 2.5GHz $d = 2.3 \sqrt{P}$
0.01	0.12	0.23
0.1	0.38	0.73
1	1.2	2.3
10	3.8	7.3
100	12	23
<p>For transmitters rated at a maximum output power not listed above, the recommended separation distance d in metres (m) can be estimated using the equation applicable to the frequency of the transmitter, where P is the maximum output power rating of the transmitter in watts (W) according to the transmitter manufacturer.</p> <p>Note: At 80MHz and 800MHz, the separation distance for the higher frequency range applies</p> <p>Note: These guidelines may not apply in all situations. Electromagnetic propagation is affected by absorption and reflection from structures, objects, and people.</p>		



Table 9. Immunity to proximity fields from RF wireless communications equipment (IEC 60601-1-2)

Test frequency (MHz)	Band ^a (MHz)	Service ^a	Modulation ^b	Maximum power (W)	Distance (m)	Immunity test level (V/m)
385	360 – 390	TETRA 400	Pulse modulation ^b 18 Hz	1.8	0.3	27
450	430 – 470	GMRS 460, FRS 460	FM ^c ± 5 kHz deviation 1 kHz sine	2	0.3	28
710 745 780	704 – 787	LTE Band 13, 17	Pulse modulation ^b 217 Hz	0.2	0.3	9
810 870 930	800 – 960	GSM 800/900, TETRA 800, iDEN 820, CDMA 850, LTE Band 5	Pulse modulation ^b 18 Hz	2	0.3	28
1720 1845 1970	1700 – 1990	GSM 1800; CDMA 1900; GSM 1900; DECT; LTE Band 1, 3, 4, 25; UMTS	Pulse modulation ^b 217 Hz	2	0.3	28
2450	2400 – 2570	Bluetooth, WLAN, 802.11 b/g/n, RFID 2450, LTE Band 7	Pulse modulation ^b 217 Hz	2	0.3	28
5240 5500 5785	5100 – 5800	WLAN 802.11 a/n	Pulse modulation ^b 217 Hz	0.2	0.3	9

NOTE If necessary to achieve the IMMUNITY TEST LEVEL, the distance between the transmitting antenna and the ME EQUIPMENT or ME SYSTEM may be reduced to 1 m. The 1 m test distance is permitted by IEC 61000-4-3.

^a For some services, only the uplink frequencies are included.

^b The carrier shall be modulated using a 50 % duty cycle square wave signal.

^c As an alternative to FM modulation, 50 % pulse modulation at 18 Hz may be used because while it does not represent actual modulation, it would be worst case.

Table 10. Cables (IEC60601-1-2)

Cables and Sensors	Maximum Length	Complies with
Pads cable	1.8 m	-RF emissions, CISPR 11, Class B/ Group 1 -Electrostatic discharge (ESD), IEC 61000-4-2 -Radiated RF, IEC 61000-4-3 -Power frequency Magnetic field, IEC 61000-4-8